



# LIQUEFIED NATURAL GAS

---

A Complete Fluid Motion and Control Portfolio to Enable Your Energy Transition Initiatives

VALVE AND AUTOMATION PACKAGES | COMPRESSOR AND PUMP SEALING SOLUTIONS | PUMPS AND SYSTEMS



# A CLEANER WAY FORWARD

Liquefied natural gas (LNG) will play a pivotal role as companies transition from coal and oil to cleaner energy sources during renewed efforts to significantly reduce the greenhouse gases that contribute to climate change.

Nations as well as businesses are pursuing strategies for decarbonization to limit greenhouse gases (GHGs). In response, natural gas is emerging as the fossil fuel of choice. Burning it emits up to 50% less carbon dioxide (CO<sub>2</sub>) emissions than coal.<sup>1</sup> That's the value of natural gas as a primary feedstock for energy production and conversion to hydrogen (H<sub>2</sub>).

Natural gas also is expected to remain the key backup fuel during intermittent outages that naturally occur with increasingly popular renewable power sources, such as wind and solar.<sup>1</sup>

It's no wonder then that LNG is one of the fastest-growing commodities; global demand is expected to rise as much as 50% by 2030.<sup>1</sup>



## Your partner for end-to-end LNG solutions

There's a new bottom line across industries: the escalating importance of LNG will significantly impact how companies achieve their objectives for sustainability as well as their future profitability.

Flowserve understands these challenges throughout the LNG value chain. And we're prepared to support your energy transition initiatives with end-to-end solutions using our proven fluid motion and control products, services and expertise.

### A better way to reduce CO<sub>2</sub> emissions

Burning LNG to generate energy results in fewer emissions of CO<sub>2</sub> compared to the combustion of coal or petroleum products to produce an equal amount of energy<sup>ii</sup>.

**91+ kg**  
(200+ lb)

The amount of CO<sub>2</sub> produced  
per million British thermal units  
(MMBtu) of coal

**73+ kg**  
(160+ lb)

The amount of CO<sub>2</sub> produced  
per MMBtu of distillate fuel oil

**~53 kg**  
(~117 lb)

The amount of CO<sub>2</sub> produced  
per MMBtu equivalent of  
natural gas



# ONE EXPERT CHOICE TO HELP WITH ALL OF YOUR LNG PROCESSES

Flowserve is not just an equipment supplier. From the early presale phase all the way to startup and commissioning, we're your ideal partner with the right products, engineering prowess, services and expertise to identify opportunities that enhance process efficiency, control costs, and achieve your energy transition objectives.

- The most **complete portfolio of fluid motion and control equipment** designed to enhance reliability, availability and maintainability (RAM) in order to achieve and sustain operational excellence.
- An **end-to-end industrial internet of things (IIoT) suite** of solutions that can:
  - Increase process and operational efficiency with remote monitoring
  - Utilize predictive analytics to anticipate equipment failures before they happen
  - Enable operators to take preventive measures to avoid process disruptions
- **Project planning and design reviews** with engineering, procurement and construction (EPC) contractors to meet critical schedules.
- **Cohesive commissioning, testing and operations support** with plant managers and technicians to meet performance objectives.
- **Unparalleled service and technical support** expertise backed by our global network of engineering and service centers.



## The right solutions along the LNG value chain

Designed to meet the latest industry standards for fugitive emissions, Flowserve fluid motion and control systems can help companies decarbonize as well as mitigate emissions throughout the processing, transportation and consumption of LNG.

Here's where emissions<sup>iii</sup> typically occur before LNG reaches end users\*:

<b>Upstream</b>	<b>7 to 19%</b>
<b>Liquefaction</b>	<b>8 to 10%</b>
<b>Shipping</b>	<b>3 to 4%</b>
<b>Regasification</b>	<b>3 to 5%</b>

\* End-use combustion of natural gas accounts for at least two-thirds of all emissions in the LNG value chain.





# YOUR COMPREHENSIVE FLUID MOTION AND CONTROL PORTFOLIO

**Valves, automation, compressor and pump seals, and pumps engineered as end-to-end solutions**

LNG companies rely on Flowserve to help them solve their most complex fluid motion and control challenges. We deliver more than the most complete portfolio of valves, automation, compressor and pump seals, and pumps. As a result, we offer the process expertise that comes from knowing how all these products and systems best work together to enable our customers to achieve operational, energy transition and sustainability goals.

**Leverage our extensive LNG process expertise**

Profitable performance requires critical process equipment and systems to operate safely and reliably as well as at maximum efficiency. Helping you meet these expectations drives everything we do.



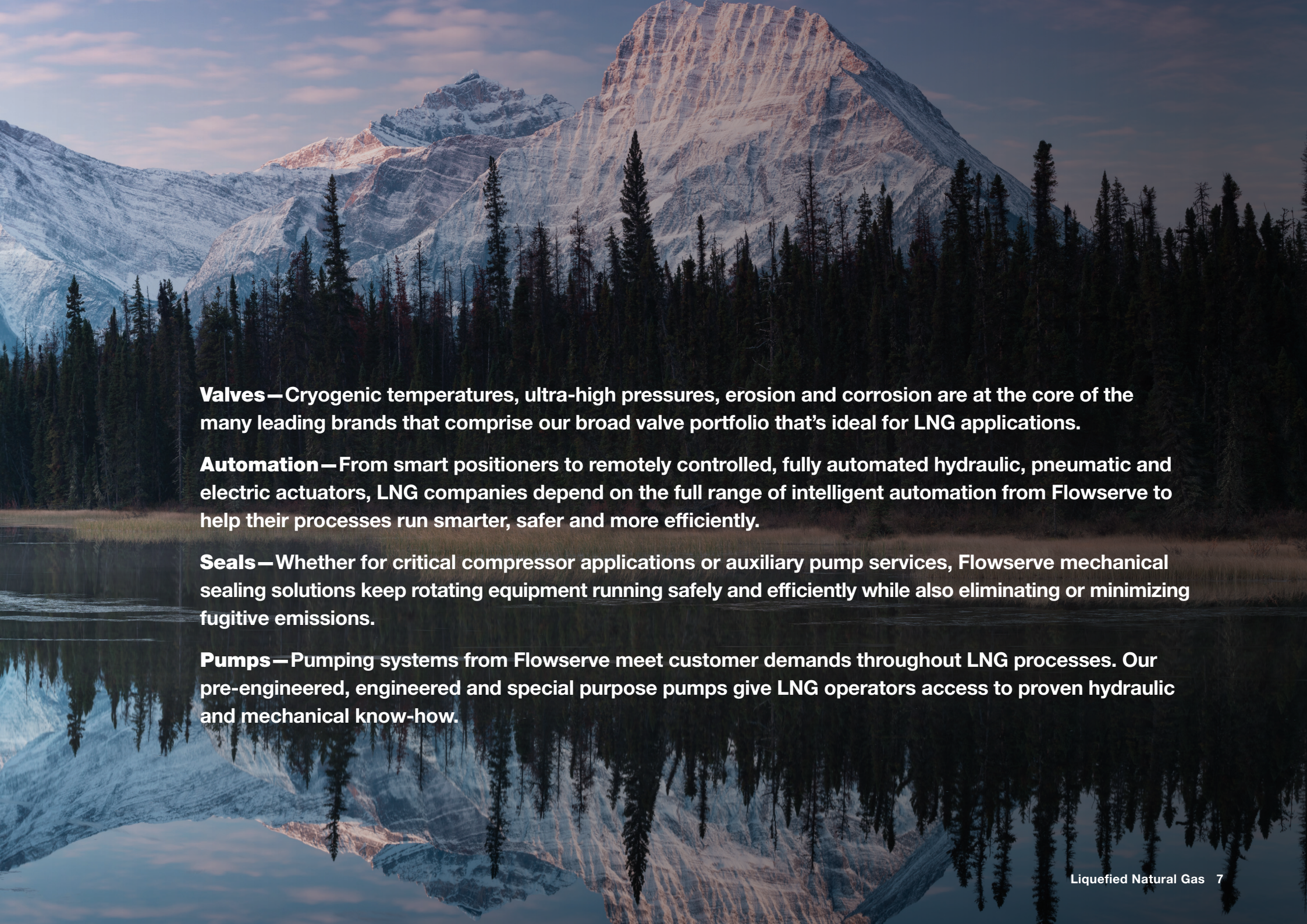

**Valves**—Cryogenic temperatures, ultra-high pressures, erosion and corrosion are at the core of the many leading brands that comprise our broad valve portfolio that's ideal for LNG applications.

**Automation**—From smart positioners to remotely controlled, fully automated hydraulic, pneumatic and electric actuators, LNG companies depend on the full range of intelligent automation from Flowserve to help their processes run smarter, safer and more efficiently.

**Seals**—Whether for critical compressor applications or auxiliary pump services, Flowserve mechanical sealing solutions keep rotating equipment running safely and efficiently while also eliminating or minimizing fugitive emissions.

**Pumps**—Pumping systems from Flowserve meet customer demands throughout LNG processes. Our pre-engineered, engineered and special purpose pumps give LNG operators access to proven hydraulic and mechanical know-how.



# TECHNICAL SUPPORT AND SERVICES

**Global engineering resources aftermarket services to optimize your LNG value chain**

**To maximize uptime and efficiency while reducing costs, you need robust engineering support, on-site maintenance and repairs, and advanced in-shop services.**

**We offer a broad range of engineering and technical support services across the LNG value chain — from upstream supply, liquefaction and production to shipping, regasification and downstream use.**

**These include:**

- Startup optimization and performance testing
- Shutdown, turnaround and outage planning and execution support
- Online and offline performance monitoring and internet of things (IoT) system analytics
- System assessments and optimization
- Troubleshooting and leak detection
- Upgrades and retrofits
- Configuration and calibration
- On-site and off-site maintenance and repairs
- Sizing and selection of equipment
- Training for products and systems



An aerial photograph of a river valley. The river flows through the center, surrounded by lush green and yellow trees. In the background, there are rolling hills and some buildings. The sky is clear and blue.

## Service that impacts your business objectives

Leverage our engineering consultation and aftermarket services to help you achieve tangible business results, including:

- Increased productivity
- Lower total cost of ownership (TCO)
- Mitigated risks
- Optimized performance
- Prolonged equipment life





# A REVOLUTION IN FLUID MOTION AND CONTROL IOT

## Scalable IoT solutions for your LNG plant

Precise and reliable flow control is the lifeblood of your LNG plant. We designed the RedRaven IoT platform to help you monitor, analyze and predict equipment performance — so you can proactively respond to problems and minimize disruptions and downtime.

With access to advanced analytics and trend data, you can identify the slightest changes in equipment performance, variations that can indicate a problem is looming. RedRaven uses engineered analytics, diagnostic and predictive capabilities that tell you how your LNG equipment is performing.

You won't just receive data. You'll also get real insights needed to make more informed decisions to improve your plant's efficiency, productivity and bottom line.





## Actionable insights for optimizing LNG equipment performance

Combine Flowserve's superior valves, seals and pumps with our RedRaven IoT products, analytics technology and expert services and you can:

- **Predict equipment behavior.** Respond to problems quickly and minimize disruptions and downtime. Use trend analysis data to make informed decisions that improve reliability plant-wide.
- **Refocus maintenance.** Prioritize assets that require attention by spending less time evaluating healthy equipment.
- **Enhance efficiency.** Know where all your assets are on their respective pump operating curves so you can maximize efficiency.
- **Reduce costs.** Lower the total cost of ownership (TCO) by minimizing spare part inventories.
- **Improve safety.** Alert technicians to equipment problems so they can respond quickly and at a safe distance from hazardous conditions.



# MEET AMBITIOUS NET-ZERO GOALS WITH ENERGY ADVANTAGE

**How can you urgently decarbonize operations to meet increasingly ambitious net-zero goals?**

**With the Energy Advantage Program from Flowserve.**

**Utilize our engineering expertise, systematic, data-driven evaluation process, and a complete offering of proven products and services so you can:**

- Take a holistic flow control approach so you can reach your carbon reduction goals and lower your total cost of ownership
- Drive increased energy efficiency through the optimization of pump and valve power consumption
- Improve plant productivity and reliability, and provide operational savings
- Accelerate energy transition plans quickly and cost-effectively



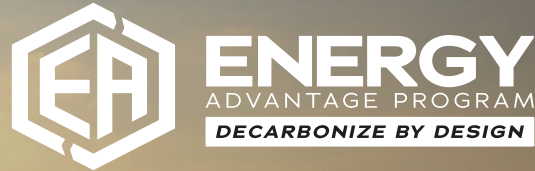

## Accelerate your energy transition plans quickly and cost-effectively

Whether you're a senior executive looking across the enterprise for ways to accomplish ambitious business objectives and ESG commitments, or you're an operational leader responsible for maximizing LNG process performance, the Flowserve Energy Advantage Program includes three offerings that can help:

- **Carbon Advantage** offers a range of cost-effective, tailored solutions to reduce hydrocarbon and greenhouse gas emissions.
- **Efficiency Advantage** enables significant efficiency gains by optimizing pump and valve energy consumption and effective recapture of wasted energy.
- **Cost Advantage** provides multiple service offerings along with comprehensive digital solutions focused on increasing equipment reliability, reducing maintenance spend, and optimizing operational expenses.



# SUPERIOR SOLUTIONS THROUGHOUT THE LNG VALUE CHAIN

Speed and reliability are critical to your ability to meet ever-increasing demand for LNG. Ensure high flow rates and precision control — while also meeting all contracted quality requirements — with valves, automation, compressor and pump seals, and pumps from Flowserve that are ideal for each step in your LNG production.

## Inlet facilities and acid gas removal (AGRU)

Remove acid gas/Hg from the feed gas in order to meet LNG specifications and prevent freezing in the cryogenic sections of the plant. The acid gas components are predominantly CO<sub>2</sub> with trace quantities of hydrogen sulfide (H<sub>2</sub>S) and other sulfur species.

- Eliminate contaminants to contracted levels.
- Ensure uptime and avoid damaging downstream cryogenic equipment.
- Maintain permitted emissions levels.

## Dehydration

Located downstream of the AGRU. The amine solution of the AGRU saturates the feed gas with water, which is removed in the dehydration unit.

- Increase throughput and uptime.
- Ensure safety and protect gas handling equipment.
- Enhance energy efficiency.

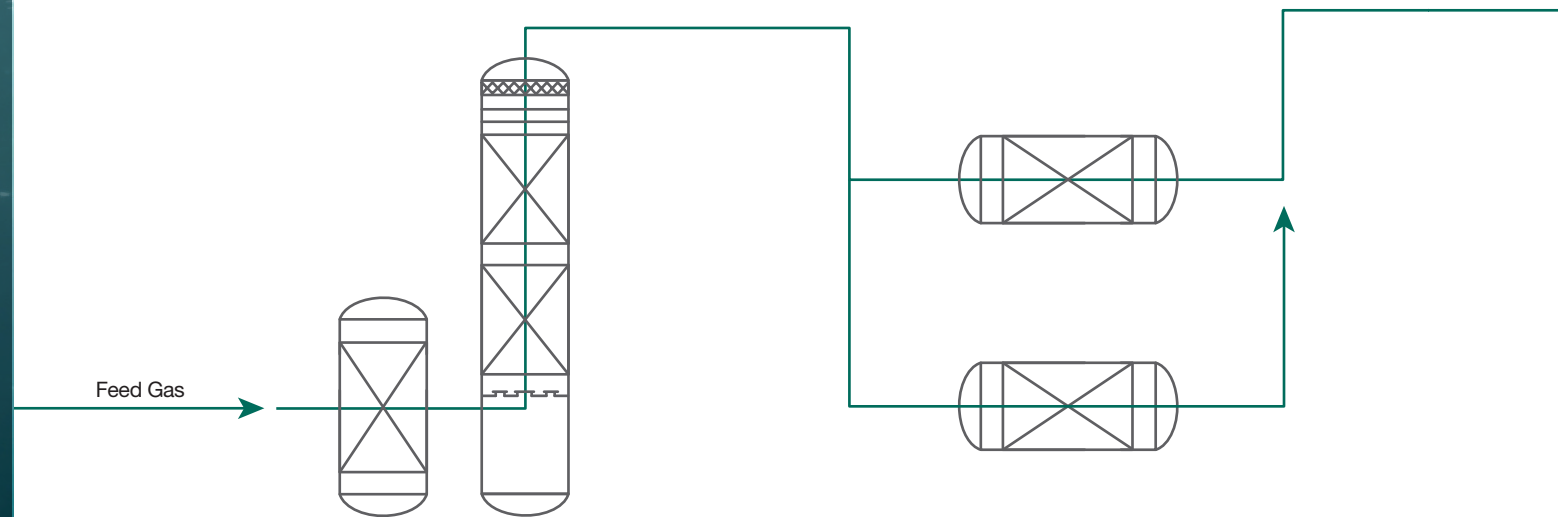



## NGL extraction

An NGL/heavies removal unit removes sufficient C5 and heavier components (including freeze components) from the natural gas, leaving the dehydration unit to meet the LNG product specification and avoid the potential for condensation or freezing of these components in the downstream liquefaction and refrigeration unit. The extracted heavy hydrocarbons are processed in the stabilizer to meet the required condensate specification and then routed to condensate storage.

- Maximize recovery of heavy hydrocarbons for resale or use as refrigerants in subsequent LNG processes.
- Meet condensate specifications.
- Avoid freezing in downstream liquefaction and refrigeration processes.

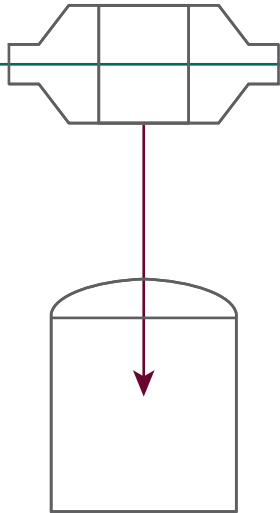

## Condensate storage and loading

Store heavy hydrocarbon components separated during LNG processes for resale as feedstock for petrochemical production and as fuel for vehicles, heating and cooking.

- Reliably control high flow rates of condensates.
- Minimize fugitive emissions with valve packing during loading into tanks and for shipment.
- Comply with fire, safety and explosion-proof standards.

## Liquefaction and refrigeration

Produce LNG at  $-162^{\circ}\text{C}$  ( $-260^{\circ}\text{F}$ ) by removing heat from dry, treated feed gas arriving from the NGL/heavies removal unit.

The liquefaction process is the propane pre-cooled mixed refrigerant process. The treated natural gas stream from the NGL/HRU is pre-cooled by propane vaporizers before entering the main cryogenic heat exchanger, where the gas is liquefied and sub-cooled by mixed refrigerant (MR). The LNG stream leaving the main cryogenic heat exchanger is let down in pressure across a hydraulic turbine and routed to storage.

- Valves, automation, compressor and pump seals, and pumps must perform reliably at cryogenic ranges.
- Protect compressors from catastrophic surge damage.
- Ensure precision control and high flow rates.

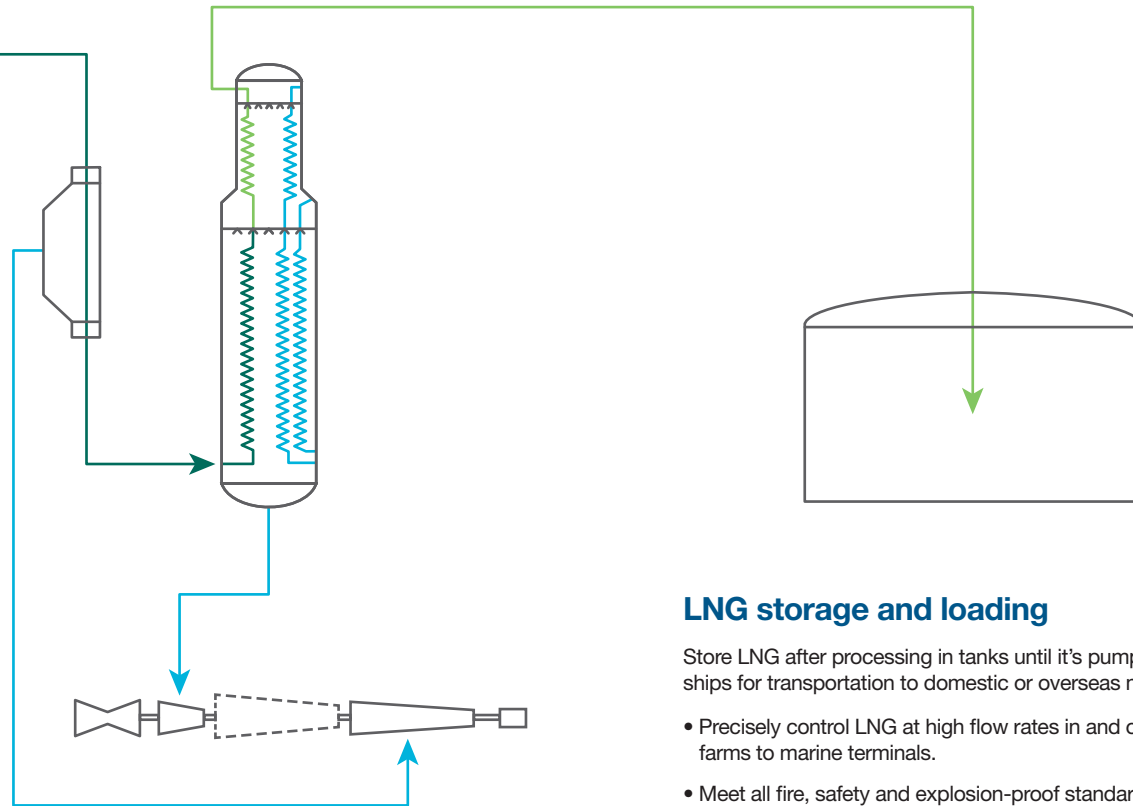

## LNG storage and loading

Store LNG after processing in tanks until it's pumped aboard ships for transportation to domestic or overseas markets.

- Precisely control LNG at high flow rates in and out of tank farms to marine terminals.
- Meet all fire, safety and explosion-proof standards.
- Minimize leakage and recover boil-off gas (BOG) vapors.



# RELIABLE AND PRECISE EQUIPMENT FOR LNG PROCESSES

At each step in your LNG processes, proven valves, automation, compressor and pump seals, and pumps from Flowserve can meet your unique requirements with precision, reliability and efficiency.

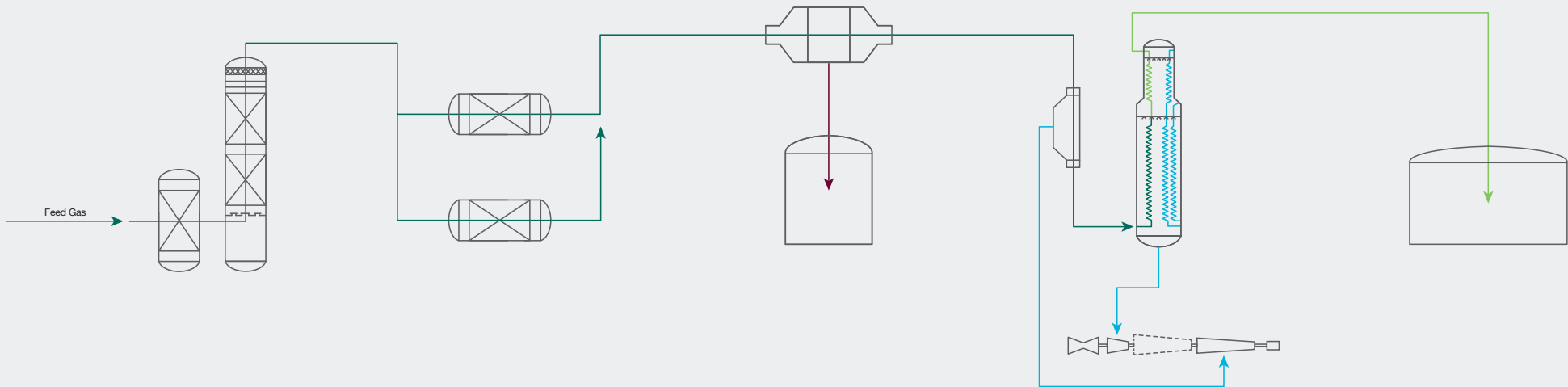



## Valves

- Durco® Big Max BX2001 double-offset butterfly valve
- Durco TX3 triple-offset butterfly valve
- McCANNA™ McCannaSeal top-entry ball valve
- Valbart® RSBV rising stem ball valve
- Valbart TMCBV side-entry, trunnion-mounted control ball valve
- Valbart VB2 side-entry, trunnion-mounted ball valve
- Valbart VT1 top-entry, trunnion-mounted ball valve
- Valtek® compressor anti-surge valve
- Valtek DiamondBack™ cavitation elimination trim
- Valtek Mark 100 high-capacity control valve
- Valtek Mark One™ globe control valve
- Valtek MaxFlo® 4 eccentric rotary plug control valve
- Valtek MegaStream™ noise reduction trim
- Valtek TX3 triple-offset butterfly control valve
- Valtek Valdisk™ high-performance butterfly valve

- Worcester® 829 two-piece, full port flanged ball valve
- Worcester C44 cryogenic ball valve

## Automation

- Automax™ Supernova rack-and-pinion actuator
- Limitorque® LPS Scotch yoke actuator
- Limitorque LPC compact Scotch yoke actuator
- Limitorque LRP rack-and-pinion actuator
- Limitorque QX non-intrusive electric actuator
- Logix™ 3800 digital positioner
- Norbro™ 40R rack-and-pinion actuator
- Valtek VL linear cylinder actuator
- Valtek VL-ES external spring linear cylinder actuator
- Valtek VR rotary cylinder actuator

## Seals

- Ampliflow seal gas booster
- Circpac circumferential separation seal
- Cleanpac gas filter

- Gaspac dry gas compressor seal
- GF-200 gas barrier seal
- GSL containment seal
- HSH balanced, high-pressure pusher seal
- ISC2-682PX single-cartridge pusher seal
- QBB balanced pusher seal
- QBQ and QBQ LZ pusher seals

## Pumps

- Byron Jackson® HDB high-pressure, double volute, barrel pump
- Byron Jackson HDO high-pressure, double volute, BB5 barrel pump
- CPXV single-stage vertical sump pump (VS4)
- DMX axially split, multistage BB3 pump
- Durco ESP3 chemical sump pump
- Durco Mark 3™ single-stage OH1 pump
- Durco Mark 3 ISO single-stage OH1 pump
- DVSH single-stage, axially split, BB1 pump
- HPX centerline mounted OH2 pump

- HWMA vertical, inline OH3 pump
- IDP® WCC medium-duty, diffuser-style barrel pump (BB5)
- IDP CHTA high-pressure, diffuser-style barrel pump
- IDP MSX solids-handling submersible pump
- VTP vertical turbine pump (VS1)
- Worthington® ECPJ VS4 sump pump
- Worthington LNN single-stage, axially split pump
- Worthington LPN single-stage, axially split BB1 pump
- Worthington LR single-case, axially split pump
- Worthington QL vertical turbine pump (VS2)
- Worthington WUC double case, vertical VS6 pump
- Worthington WUJ vertical wet-pit VS1 pump
- Worthington WXB medium-duty, diffuser-style, BB5 barrel pump



# END-TO-END SOLUTIONS: VALVES AND AUTOMATION

Enhance performance with engineered precision, reliability and productivity

Operators can overcome common challenges experienced in LNG processes by investing in the broad range of Flowserve valves, actuators, positioners and other automation. In addition, we offer IoT remote monitoring, asset control and predictive analytics solutions. They're designed to work together as a complete fluid motion and control system that can enable companies to:

- Achieve **maximum productivity** while reducing the risk of surges in LNG compressor applications that cause unplanned downtime
- Deliver exceptionally **fast stroke speed** while also **precisely controlling valves** with intelligent positioners
- Accomplish **commissioning and tuning in minutes** with one-button set-up
- Ensure reliable performance in harsh environments with equipment designs that eliminate complexity
- **Minimize emitted noise and vibration** that can cause equipment wear or damage
- **Simplify maintenance** and upgrades
- Meet environmental standards and **ensure fugitive emissions compliance**, regardless of how extreme the conditions







# Cut Fugitive Emissions With Zero-Leakage Shutoff

## Highly reliable TX3 butterfly valve design ensures compliance

Meeting fugitive emissions standards plus fire-safe design and anti-blowout requirements are top priorities for LNG operators. TX3 butterfly valves offer excellent shutoff capabilities to ensure safety and compliance in the most demanding applications.

The precision seat and seal are machined at an offset angle, creating even seat loading around the entire seat ring and eliminating rubbing between the seat and seal during opening and throttling. Combined with a laminated seat ring, the TX3 valve's triple-offset design provides long-lasting, bi-directional, bubble-tight shutoff, even in gas applications.



## Advantages and benefits

- **Maximize reliability** — API 598 zero-leakage shutoff assured by triple-offset design and laminated metal graphite seat seal.
- **Extend service life** — Low-operating torque results from the low-friction, low-wear elliptical sealing surfaces.
- **Minimize emissions** — Packing options meet stringent ISO 15848-1 fugitive emissions requirements.
- **Improve safety** — API 607 fire-safe design plus API 609 anti-blowout shaft



## Durco TX3 triple-offset butterfly valve



Eliminate leaks — even in gas service — with this manual or automated isolation valve boasting bi-directional, bubble-tight shutoff per API 598.

- Assure environmental compliance with packing options that meet ISO 15848-1 fugitive emissions requirements.
- Improve safety with API 607 fire-safe design plus API 609/ASME B16.34 anti-blowout shaft.
- Eliminate wear from sealing surface contact and maintain sealing integrity during high-cycle operation with triple-offset design.

## Valtek TX3 triple-offset butterfly control valve



Realize precision control with this automated valve package that provides API 598 zero-leakage shutoff along with long-lasting, reliable performance.

- Extend service life and minimize actuation costs with low-operating torque arising from low-friction, low-wear elliptical sealing surfaces.
- Meet industry safety standards with API 607 fire-safe design plus API 609/ASME B16.34 anti-blowout shaft.
- Minimize fugitive emissions with packing options that meet ISO 15848-1 requirements.

## Valtek Valdisk high-performance butterfly valve

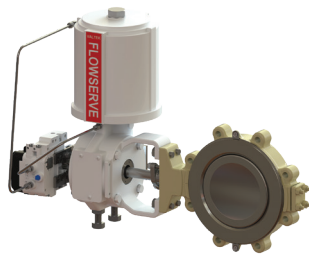

Ensure high-capacity performance with bi-directional Class IV or VI shutoff and low pressure loss with this cost-effective valve package.

- Get unmatched performance, even in large pressure drops, owing to high-thrust cylinder actuator and eccentric-cammed disc.
- Ensure greater throttling accuracy with low breakout torque provided by jam-lever toggle seating.
- Improve uptime and reduce maintenance costs with double-offset design that minimizes wear and leakage.

## Durco Big Max BX2001 double-offset butterfly valve



Achieve reliable on-off performance with this cost-effective, all-purpose valve package featuring a compact valve design and energy-efficient actuator.

- Reduce fugitive emissions through triple-leak protection of primary stem seal plus two optional secondary seals.
- Increase capacity and improve flow control with low-profile, double-offset disc.
- Increase personnel and plant safety with anti-blowout protection per API 609.



# Advanced Trim Minimizes Noise and Vibration



## Proven technologies for LNG's most challenging applications

Industry-leading, noise-abatement and anti-cavitation trims available for Valtek globe valves can ensure LNG operators minimize — if not eliminate — control valve noise and vibration.

Applied technologies significantly reduce noise 30 to 40 dBA through staging, frequency shifting, phase cancelation, velocity control and our patented WaveCracker technology. In the most challenging LNG applications, staged pressure drops eliminate cavitation.

## Advantages and benefits

**Meet your exact trim requirements** — Wide variety of anti-cavitation and noise reduction trims expands the service usability across a broad range of LNG applications, including cryogenic:

- Standard full-area trim provides maximum Cv.
- Reduced trim is available when lower Cv values and large body expansions are required.
- Custom-engineered trims are tailored to exact process conditions.



## Valtek Mark One globe control valve



Ensure superior control and throttling performance in liquid or gaseous service with this versatile and easy-to-maintain automated valve package.

- Get position accuracy, repeatability and faithful response with digital positioner and stiff, high-thrust, double-acting piston cylinder actuator.
- Lower installation and maintenance costs with a compact package featuring top-entry, clamped-in, self-aligning seat and trim.
- Application flexibility provided by numerous severe service trim options; cryogenic configuration available.

## Valtek Mark 100 high-capacity control valve



Achieve extra-fine process control in high-capacity liquid or gaseous applications with this cost-effective automated valve.

- Lower initial costs with a higher-capacity design that enables more cost-effective valve sizes to be used.
- Get precision control with longer-than-typical stroke lengths combined with double top stem and cage guiding.
- Accomplish reliability, accessibility and maintainability (RAM) goals with a clamped-in, self-aligning seat and top-entry trim.

## Valtek DiamondBack cavitation elimination trim

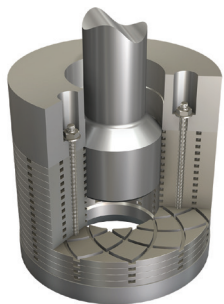

Eliminate cavitation in even the most challenging liquid applications with the most advanced anti-cavitation trim design in the industry.

- Prevent cavitation from forming and minimize hydrodynamic noise using staged pressure drops resistant to erosion and plugging.
- Customize trim to application requirements; available in a wide range of materials.
- Simplify maintenance with easy-to-clean stacked disc design.

## Valtek MegaStream noise reduction trim



Effectively reduce control valve noise and vibration in a wide range of gas applications through staging, frequency shifting, attenuation and velocity control.

- Achieve noise attenuation up to 30 dBA, improving the safety of personnel.
- Extend valve and system life by reducing downstream noise and acoustic-induced vibration (AIV) and flow-induced vibration (FIV) fatigue failure.
- Realize cost-effective, reliable and long-lasting performance derived from heavy-duty, nested cylinder design.





# Revolutionary LNG Anti-Surge Control With Unprecedented Speed

## Increase productivity without damaging compressors

Protect compressors in LNG processes from catastrophic surge damage by providing exceptional response for driving the compressor valve open when needed and in a steady-state position when recycling. This enables operators to run compressors near

the surge line for increased productivity in the most challenging applications, including natural gas liquefaction.

In addition, Valtek compressor anti-surge valves are easy to calibrate; one-button configuration simplifies set-up and tuning.





## Valtek compressor anti-surge valve

Protect compressors from catastrophic damage with a revolutionary anti-surge solution that delivers unprecedented control *and* exceptional responsiveness in a reliable and easy-to-use package.

- Overcome the conflict between precision and speed without compromise by replacing volume boosters with the advanced Logix 3800JF positioner.
- Set up and tune the valve package in minutes instead of hours with one-button configuration.
- Ensure high-capacity performance with an angle body valve that has 51 to 248% greater capacity compared to similar offerings.
- Extend service life and reduce system wear with advanced trims that deliver high flow rates while reducing noise and vibration.

### Advantages and benefits

- **Precision control and fast stroke speeds** — Provide both small step changes and high flow when required; the control valve system includes the JetFlow relay integrated with a Logix 3800JF intelligent positioner, which overcomes the conflict between precision and speed.
- **Eliminate auxiliary accessories** — The Logix 3800JF positioner reduces complexity, so there's no need for volume boosters. The system is tuned in minutes with a single button push.
- **Keep noise and vibration low** — Advanced trims, such as MegaStream and Stealth, provide industry-leading flow rates while keeping emitted noise and resulting vibration levels low, limiting system wear or damage and minimizing maintenance labor and costs.





# Avoid Downtime While Also Ensuring Compliance

## Meet fugitive emissions compliance across LNG applications

LNG operators must keep environmental regulations for fugitive emissions in mind, especially in applications with high pressures and valve operational cycles.

The ability of a valve to contain fluids not only reduces environmental damage but also minimizes financial losses to the operator. When a valve seal or stem packing fails to prevent fugitive emissions, LNG operators can face significant costs due to unplanned downtime and repairs along with potential legal repercussions for environmental damage. In applications across the LNG value chain, we provide proven equipment and integrated solutions that enable LNG operators to ensure compliance with emissions standards.

## Advantages and benefits

- **Eliminate leaks** — Get leak-tight closure under all operating conditions with self-adjusting seat designs.
- **Minimize fugitive emissions** — Ensure environmental compliance with valves designed to relevant fugitive emissions standards, including ISO 15848, API 622 (packing), API 624 (rising stem) and API 641 (quarter-turn).
- **Improve process integrity** — Ensure performance stability and longevity with high-strength materials, customized seat options and multiple pack offerings.
- **Lower maintenance costs** — Improve reliability and sealing capability with valve designs that allow for thermal expansion, thereby minimizing contact between pressure-loaded parts and ensuring extended seat life.



## Valbart TMCBV side-entry, trunnion-mounted control ball valve



Manage high pressures while minimizing operating torque with this compact, cost-effective valve that merges trunnion-guided design with characterized control and advanced trims.

- Ensure Class IV or V shutoff at any pressure with spring-loaded, process energized seats.
- Secure savings by using a smaller valve with greater capacity and rangeability than alternative globe valves.
- Use industry-proven technologies for cavitation control and noise attenuation.

## Valbart RSBV rising stem ball valve



Maximize service life in high-cycle applications with this rising stem ball valve that provides friction-free, linear stem operation for optimal actuation.

- Reduce wear with helix coil stem design that actuates the valve without rotation.
- Prevent losses from process contamination or material leakage with mechanically energized metal or soft seat.
- Ensure process integrity with tightness performance up to ASME FCI-70-2 Class VI.

## Valbart VB2 side-entry, trunnion-mounted ball valve



Get API 6D and 6A compliance along with double block and bleed (DBB) capability; cryogenic configuration available.

- Assure bi-directional sealing with two independent floating seats.
- Reduce actuation costs with seat design that minimizes the valve's operating torque without losing sealing power.
- Ensure compliance with ISO 15848 fugitive emissions standard and improve safety with anti-blowout stem.

## Valbart VT1 top-entry, trunnion-mounted ball valve



Lower maintenance and actuation costs with this in-line repairable valve that minimizes operating torque without losing sealing power; cryogenic configuration available.

- Achieve API 6D and 6A compliance along with double block and bleed (DBB) capability.
- Assure bi-directional sealing with two independent floating seats.
- Enhance safety with anti-blowout stem while also ensuring ISO 15848 fugitive emissions compliance.







## McCANNA McCannaSeal top-entry ball valve

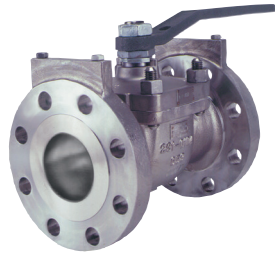

Ensure cost-effective, low-torque operation with this metal- or soft-seated floating ball valve.

- Get up to leak-tight closure under all operating conditions with self-adjusting, wedge-seat design.
- Comply with environmental standards with stem seal design that meets ISO 15848 requirements and prevents stem blowout.
- Simplify maintenance with top-entry design that permits in-line service and emergency access in minutes.

## Worcester 829 two-piece, full port flanged ball valve



Realize trouble-free operation and lower cost of ownership with this compact, ASME B16.34 compliant valve.

- Gain process flexibility from valve design that provides bubble-tight shutoff with bi-directional flow.
- Reduce space and cost requirements with low operating torque that enables use of compact actuation.
- Meet ISO 15848 fugitive emission requirements with fire-rated graphite gland packing and PTFE-coated graphite body seals.

## Worcester C44 cryogenic ball valve



Provide reliable shutoff in intermittent or continuous cryogenic applications down to  $-254^{\circ}\text{C}$  ( $-425^{\circ}\text{F}$ ) with this three-piece, flanged ball valve specifically designed for liquefied gases.

- Maintain safety with fire-tight configuration, blowout-proof stem and an overpressure-relief ball design.
- Ensure tight shutoff with zero body leakage and low torque through thermal excursions with Polyfill® seats and body seals and Belleville live-loaded TFE packing rings.

## Valtek MaxFlo 4 eccentric rotary plug control valve



Attain higher rangeability and capacity plus precise control with this cost-competitive general service valve.

- Use smaller, more cost-effective valves with high Cv design — up to 70% greater per size.
- Substantially improve control and service life with robust polygon shaft/plug and splined actuator connection.
- Ensure Class IV (metal seat) or VI (soft seat) shutoff with double-offset, eccentric plug design that reduces seat wear.





# Anticipate Issues With Advanced IoT Diagnostics

## Next-generation positioner predicts action that safely maintains LNG production

The Logix 3800 digital positioner coupled with any one of a variety of precision actuators enables improvements in LNG process uptime, reliability and throughput. Advanced diagnostics not only identify developing problems in the control valves, but also help guide corrective actions to ensure reduced return-to operation times.

The next-generation actuation equipment is enabled for the internet of things (IoT), offering embedded measurement, data reduction and diagnostic functionalities. Its user interface (UI) facilitates easy configuration, operation and system diagnostics within a single view.

## Advantages and benefits

- **Anticipate and avoid issues** — Powered by ValveSight DTM, the Logix 3800 positioner has five onboard pressure sensors that enable LNG operators to identify and assess the severity of developing problems so action can be taken before a critical event.
- **Trouble-free performance** — Reliable uptime in demanding LNG applications is ensured by the shielded, dual-element, non-contact, magneto-resistive position sensor and temperature-compensated, dual-poppet pneumatic relay.
- **Easy configuration and calibration** — One-button setup automatically configures the zero, span and gain of the positioner for most valves in less than 60 seconds.
- **Enhance safety** — Non-incendive and explosion-proof design from -52°C to 185°C (-62°F to 365°F) ensures reliable operation in hazardous conditions. Meets SIL 3 safety integrity standards; certified for use in explosion-proof Exd IIC hazardous locations.



## Logix 3800 digital positioner



Maximize production and reduce operating costs with this next-generation smart positioner.

- Minimize downtime with predictive diagnostics that help identify field problems and expedite corrective actions.
- Simplify setup with quick-calibration button that automatically configures the zero, span and gain in less than 60 seconds.
- Get application flexibility due to compatibility with all standard communication protocols as well as linear and rotary applications.

## Limitorque LRP rack-and-pinion actuator



Ensure high performance in quarter-turn applications with this balanced double rack-and-pinion pneumatic actuator.

- Improve service life and performance stability with support rod design that makes sure side loads are transmitted through the bearings, not the body.
- Match torque requirements precisely, owing to linear torque curve and large range of sizes.
- Simplify installation with ISO 5211 and NAMUR VDI/VDE 3845 mounting patterns.

## Limitorque LPS Scotch yoke actuator



Reliably automate on/off, inching and modulating applications using medium to large quarter-turn valves.

- Ensure regulatory compliance with the highest industry standards, including EN 15714 and IEC 61508; SIL 3 capable.
- Lower ownership costs with 25-year design life and maintenance intervals up to six years.
- Reduce maintenance costs with modular construction that enables on-site service without special tools and removal from the valve.

## Limitorque LPC compact Scotch yoke actuator

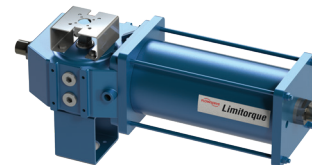

Take advantage of this compact pneumatic actuator in on-off, light modulating and control applications of small or medium quarter-turn valves.

- Reduce ownership costs with 25-year lifecycle and maintenance intervals up to five years (or EN 15714 endurance testing).
- Get superior reliability and durability with heavy-duty design and excellent corrosion resistance.
- Ensure regulatory compliance, including EN 15714 and ISO 9001; SIL 3 capable.





# Automate to Optimize LNG Process Performance

## The right controls for every valve upstream, midstream and downstream

Invest in valve automation that dramatically improves the control, precision and efficiency of processes throughout the LNG value chain.

Valtek rotary and linear double-acting piston cylinder actuators provide superior resistance to dynamic fluid forces acting on the valve trim compared to diaphragm actuators. Valtek piston cylinder actuators enable control valves to reliably regulate constantly fluctuating flows by providing the pneumatic stiffness required to minimize these fluctuations. And Flowserve also provides all of the gearing your actuation equipment requires.

## Advantages and benefits

- **Ensure precise control** — Achieve excellent throttling performance and increase efficiency with high torque and pneumatic stiffness.
- **Avoid unplanned downtime** — Low-friction bearings provide millions of cycles with minimal wear to reduce maintenance and lower the total cost of ownership.
- **Simplify installation and maintenance** — Actuator design provides easy access to internal components with a compact, lightweight footprint available in some models.





## Valtek VR rotary cylinder actuator

Ensure excellent throttling performance with high torque and pneumatic stiffness with this compact, double-acting piston cylinder actuator.

- Achieve precise control and eliminate backlash with rocking piston and splined shaft connections.
- Get long service life with low-friction bearings that provide millions of cycles with minimal wear.
- Eliminate the need for a pressure regulator with capability to handle supply air pressures to 150 psi (10.3 bar).



## Valtek VL linear cylinder actuator

Realize solid throttling or on-off operation for linear control valves with this compact, high-performance, double-acting, piston cylinder actuator.

- Increase efficiency and achieve tighter valve shutoff with substantially higher thrust capability compared to diaphragm actuators.
- Simplify maintenance with cylinder design that provides easy access to all internal components.
- Achieve superior process control with longer stroke lengths and lower air consumption than comparable diaphragm actuators.



## Valtek VL-ES external spring linear cylinder actuator

Ensure precise control in applications where longer strokes or unusually high spring thrust is required.

- Get exceptionally stiff performance with minimal air volumes, stronger springs, plug stem jam nut and thrust bearings that prevent windup.
- Simplify installation and maintenance with compact, lightweight design that requires the removal of just two parts to access internals.









## Norbro 40R rack-and-pinion actuator

Ensure accuracy and reliability in quarter-turn applications with this double-acting or spring-return actuator.

- Improve control, minimize wear, and extend service life with unique moving guide rod design that limits travel in both stroke directions while eliminating the need for the body to be used as a bearing surface.
- Get application versatility with multi-spring design that provides variable torque/air requirements.



## Automax Supernova rack-and-pinion actuator

Get precision and trouble-free operation in quarter-turn applications with this rugged, compact actuator designed for double-acting or spring-return operation.

- Achieve greater control and reliability with integral travel stops in both stroke directions, plus 10 degrees of overtravel for precise adjustment.
- Maximize service life with rugged construction that includes precision-extruded, hard-anodized aluminum body and a one-piece, factory-lubricated, nitride-protected pinion gear.



## Limitorque QX non-intrusive electric actuator

Get precision automation of quarter-turn multiport and control valves with this smart actuator that features 100% solid state controls; suitable down to -55°C (-67°F).

- Assure greater process control and position sensing with battery-free, non-contacting absolute encoders.
- Enhance safety and reduce downtime through improved diagnostics, built-in self-test (BIST) features and LimiGard™ fault protection.
- Simplify commissioning with flexible control configurations, setup and diagnostics in 11 languages.



# ROTATING EQUIPMENT EXPERTISE: SEALS AND PUMPS

## Optimize system performance and efficiency

LNG processes impose many demands on pump and sealing solutions. Inferior or poorly specified equipment can lead to leaks — or worse yet, premature or catastrophic failures.

The potential harm to personnel, environmental contamination and productivity losses can jeopardize business objectives. They also can expose your company to regulatory penalties.

Whether it's compressors or pumping systems, we understand how sealing solutions and rotating equipment should work together throughout the entire LNG value chain. As a result, Flowserve can help you engineer, design, commission and maintain end-to-end solutions so they perform optimally.



A photograph of several large, white, spherical LNG storage tanks at an industrial facility during sunset. The sky is filled with orange and purple clouds, and the sun is low on the horizon, creating a bright lens flare effect. A tall, yellow tower is visible on the left side of the image. The foreground shows a rocky beach with waves crashing against the shore.

## **A global commitment to reliability, availability and maintainability (RAM)**

**In LNG facilities, it's all about equipment uptime. That's why we engineer our sealing solutions and pumping systems to perform consistently and reliably under the high pressures and ultra-low temperatures found in plants, terminals and aboard carrier ships.**

**Availability is key. We design our compressor and pump seals and pumping systems to extend mean time between repair (MTBR) and service life.**

**And our worldwide network of manufacturing facilities, Quick Response Centers and certified repair shops helps operators maintain equipment to ensure it's available to keep production on target. Whether you need spare parts, repairs or other technical support, Flowserve helps you minimize unplanned downtime and make sure sealing solutions and pumping systems are maintained in optimal working condition so they're ready when you need them.**



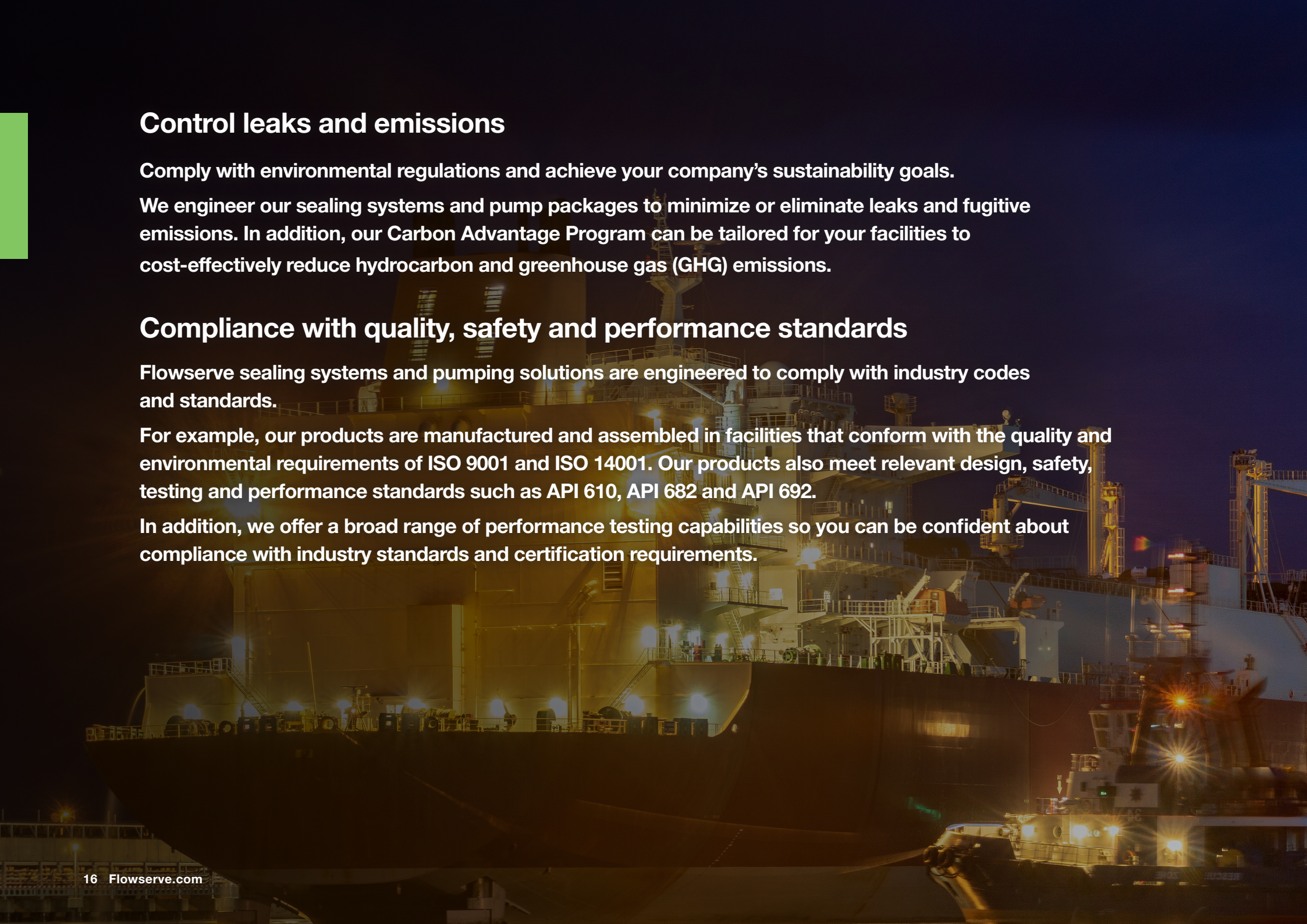

## Control leaks and emissions

Comply with environmental regulations and achieve your company's sustainability goals.

We engineer our sealing systems and pump packages to minimize or eliminate leaks and fugitive emissions. In addition, our Carbon Advantage Program can be tailored for your facilities to cost-effectively reduce hydrocarbon and greenhouse gas (GHG) emissions.

## Compliance with quality, safety and performance standards

Flowserve sealing systems and pumping solutions are engineered to comply with industry codes and standards.

For example, our products are manufactured and assembled in facilities that conform with the quality and environmental requirements of ISO 9001 and ISO 14001. Our products also meet relevant design, safety, testing and performance standards such as API 610, API 682 and API 692.

In addition, we offer a broad range of performance testing capabilities so you can be confident about compliance with industry standards and certification requirements.



## Engineered to application needs

Match your exact LNG process requirements with standard and customized equipment, systems and complete solutions from Flowserve.

In addition, we provide vital NPSH calculations so that operators can prevent cavitation in order for pump systems to function efficiently, minimize noise, and extend the equipment lifecycle. And we offer performance testing to ensure pumps and seals meet or exceed your application specifications.

## More effective asset management

Condition monitoring is an effective means of improving rotating equipment reliability in LNG processes. That's why we offer built-in monitoring technologies for many of our sealing systems.

It's also why Flowserve introduced RedRaven, an end-to-end IoT platform. You get advanced tools to monitor and optimize flow control equipment performance. RedRaven also enables you to proactively identify and address issues before they cause downtime and disruptions.

With RedRaven, you'll have clear insights to improve your plant's efficiency, productivity and reliability.

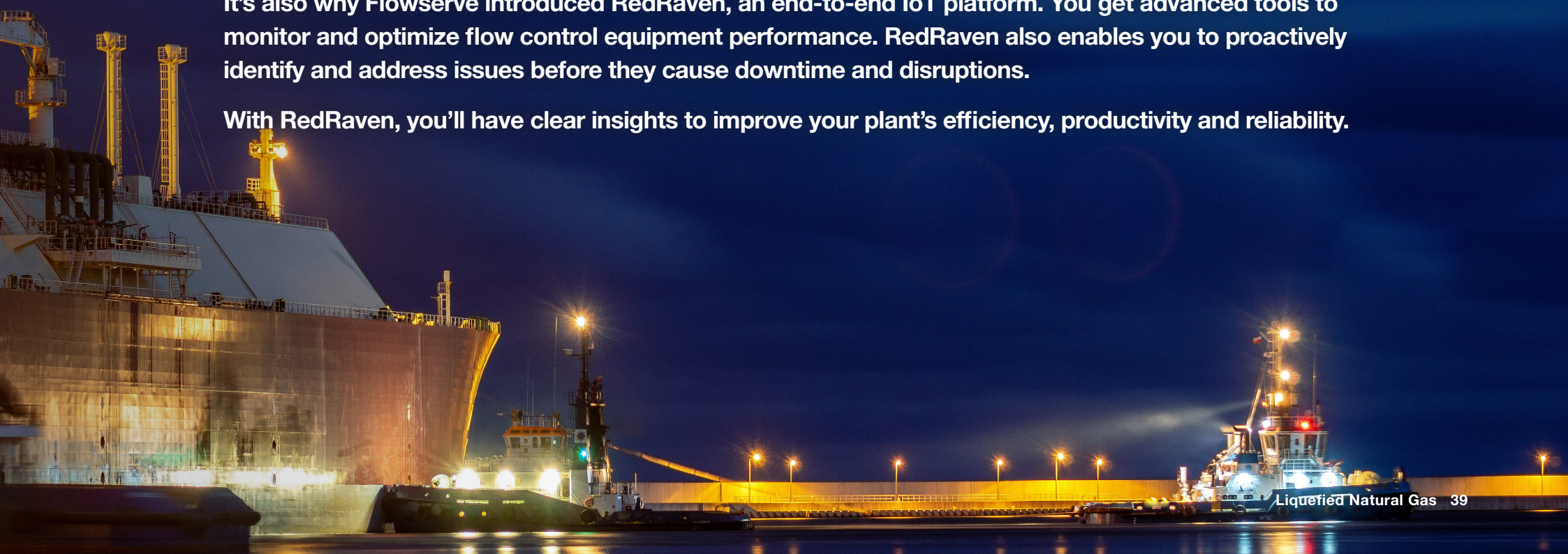





# Advanced Compressor Seals and Systems

## Industry-leading sealing technologies maximize LNG process efficiency and profitability

In compressor services, higher pressure often means higher efficiency and greater profitability. Gaspac and Circpac seals set the performance benchmark. They're the most advanced compressor sealing solutions available. And they're proven, too: Around the world, thousands of Gaspac and Circpac seals have been running for millions of hours.

What's more, our advanced seal support systems ensure operational excellence with long service intervals and little to no fugitive emissions.

## Advantages and benefits

- **Maximize performance** — Reach higher pressures and efficiencies with advanced lift-off technologies and innovative secondary seals.
- **Ensure availability** — MTBR with proven seal reliability that outlasts multiple compressor turnaround cycles.
- **Operate sustainably** — Effectively minimize or eliminate product losses and fugitive emissions with advanced sealing technologies and seal support systems.
- **Maximize uptime** — Support from our global team, who leads the industry in dry gas seal retrofits, high-end compressor seal troubleshooting, seal support engineering and world-class gas conditioning systems.



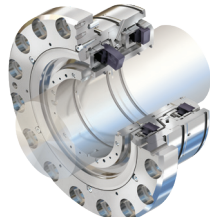

## Gaspac dry gas compressor seal

Realize unequalled uptime — even at high speeds and ultra-high pressures — with the most advanced non-contacting, lift-off technology available. Available in single, dual and tandem arrangements.

- Get more than five years MTBR or overhaul with a proven seal design that incorporates solutions for hang-up, reverse rotation, reverse pressurization and centering of rotating components.
- Achieve environmental regulatory compliance and energy savings with controlled gas flow rates over the widest operating conditions.
- Optimize performance with precision face topography that offers high film stiffness and damping, and maintains a stable gas film under all operating conditions, including slow roll and high speeds.

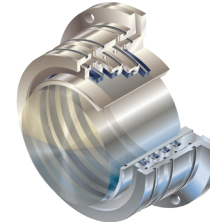

## Circpac circumferential seal

Ensure consistent dry gas compressor seal performance by preventing bearing oil contamination with this segmented carbon ring seal. Engineered for use with Gaspac dry gas compressor seals, it also can be applied as a stand-alone sealing solution.

- Achieve optimal performance and long lifecycles with pressure-balanced, non-contacting ring(s) designed for continuous operation at pressures exceeding those of typical circumferential seals while eliminating wear and minimizing maintenance.
- Lower operating costs with a pressure-balanced ring design and hydrodynamic surface features that lower gas consumption.
- Get application versatility with multiple ring combinations featuring optimized purge and vent options plus bi-directional capability for reverse rotation.





## Ampliflow seal gas booster

Improve operational reliability by providing a continuous supply of clean, filtered gas to compressor seals, even during periods of low differential pressure across the compressor.

- Get high  $\Delta p$  with the Ampliflow pneumatic piston booster.
- Choose the Ampliflow G-Boost rotary booster for medium  $\Delta p$  and extended maintenance intervals.
- Get high seal gas flow with very long maintenance intervals with the Ampliflow T-Boost rotary booster.



## Cleanpac gas filter

Remove heavy liquids with this gas filter that also includes hybrid coalesce/pre-filters and dual coalescing filter assemblies.

- Minimize downtime with a large coalescing element that extends time between change-outs.
- Lower operational costs and improve dry gas seal system reliability with filter element efficiency of  $B(0.3) > 1,000$  (99.9% @ 0.3  $\mu\text{m}$ ).







# Pump Seals

## QBQ and QBQ LZ pusher seals

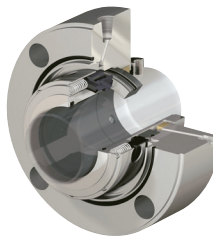

Suppress flashing and minimize heat generation with these dual pressurized seals that comply with API 682, Arrangements 1 and 2, respectively.

- Meet the lowest light hydrocarbon emissions level — less than 500 ppm — with the QBQ seal.
- Handle low vapor pressure margin with the QBQ LZ seal.
- Assure safety and environmental compliance with a dual seal arrangement that provides backup control in hazardous services.

## QB2B balanced pusher seal

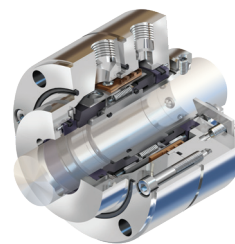

Eliminate fugitive emissions and handle reverse pressurization upsets with this face-to-back configured, dual pressurized seal that complies with API 682, Arrangement 3.

- Exceed conventional balanced seal durability under reverse pressurization conditions with components that are mechanically or hydraulically retained in place, regardless of the direction of pressurization.
- Comply with environmental regulations with a design optimized for pressurized barrier fluid.
- Simplify installation with a unitized cartridge design.



## ISC2-682PX single-cartridge pusher seal

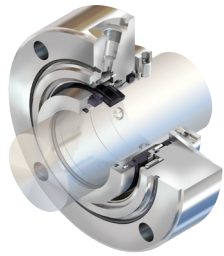

Provide reliable sealing with this versatile, balanced seal that complies with API 682, Type A requirements.

- Increase reliability with thermal management technology that runs cooler in sub-optimal conditions.
- Extend service life with a corrosion-resistant design and drive mechanisms that reduce wear.
- Ensure safe containment in the unlikely event of a seal failure with throttle bushing with standard quench and drain.

## GF-200 gas barrier seal

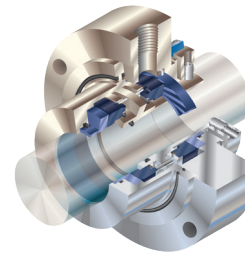

Achieve zero-emission sealing of hazardous fluids with this dual pressurized pusher seal.

- Comply with environmental regulations with inert gas barrier technology that eliminates fugitive emissions.
- Reduce operating costs with non-contacting seal faces that consume little power.
- Realize longer service life from silicon carbide seal faces with advanced pattern groove (APG) precision topography, which creates a thin gas film that prevents wear.

## HSH balanced, high-pressure pusher seal

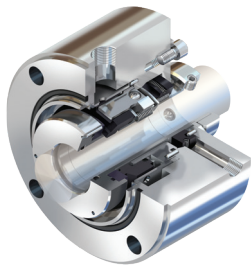

Get superior uptime in high-pressure, high-speed applications with this API 682 Type A, Arrangements 1, 2 and 3 compliant cartridge seal.

- Extend service life with high torque-capable, anti-rotation lugs that minimize distortion and wear.
- Realize more efficient operation owing to improved cooling from 360° seal face flush.
- Improve tolerance of misalignment with a flexible stator design with Alloy C-276 springs.

## GSL containment seal

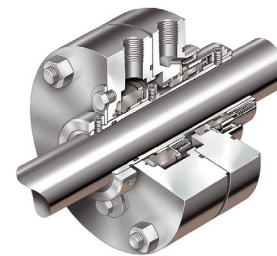

Ensure reliable dry running vapor containment with full-pressure, wet backup sealing with this API 682 Type A, Arrangement 2 compliant cartridge seal.

- Meet environmental emission limits with an available nitrogen sweep auxiliary system.
- Improve plant and personnel safety with a backup sealing capability that enables safe shutdown if the primary seal fails.
- Improve reliability and service life with non-contacting, bi-directional silicon carbide seal faces.





# Proven Pumping Solutions

## Pumps for your all your LNG processes

Whether for gas scrubbing amine loops, light and heavy hydrocarbon extraction, or storage and loading operations, LNG producers can rely on Flowserve for all their pumping needs. Backed by more than a century of expertise, our portfolio includes the charge and process pumps, transfer and circulation pumps, service and utility pumps, and specialty pumps to accomplish these tasks effectively and reliably. And, they are designed for operational excellence over the full range of production conditions, including cryogenic.

## Advantages and benefits

- **Maximize RAM** — Achieve performance and operational objectives with pump packages that Flowserve builds to requirements often exceeding industry standards and supported by our global service network that is committed to your maintenance and repair needs.
- **Work smarter** — Realize meaningful equipment and process efficiency improvements via insights gained through RedRaven from Flowserve, our IoT-enabled condition monitoring and predictive analytics solution.
- **Get the best fit** — Specify exactly the pumps you need for your unique applications from among the industry's most complete line of API 610 pumps — designed by Flowserve with the widest range of hydraulic coverage, pressure and temperature capabilities.



## Between bearings pumps

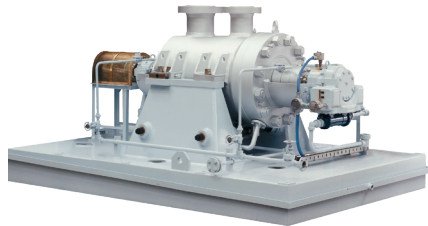

### Byron Jackson HDO high-pressure, double volute, BB5 barrel pump

Ensure the highest reliability in critical applications with this heavy-duty pump manufactured to customer specifications often exceeding API 610 (BB5) requirements.

- Maximize efficiency with the double volute, opposed impeller design that balances hydraulic loads at all operating points.
- Ensure contact-free startup with a sag bore machined volute (nine stages and higher).
- Verify performance with standard API and Hydraulic Institute performance testing.



### Worthington WXB medium-duty, diffuser- style, BB5 barrel pump

Maximize performance in medium-capacity, medium-pressure applications with this compact, maintenance-friendly, API 610 (BB5) compliant, double case pump.

- Extend uptime and bearing, mechanical seal and wear ring life with a generous shaft diameter that minimizes deflection.
- Minimize maintenance downtime with renewable wear rings and a cartridge design that allows service to be performed in shop.
- Control fugitive emissions with API 682 seal chambers.

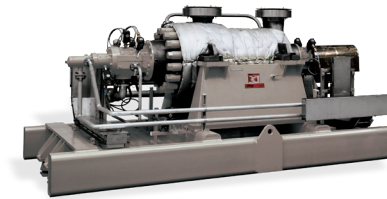

### IDP WCC medium-duty, diffuser-style, barrel pump (BB5)

Lower lifecycle costs with this versatile double case pump that is available in general purpose or API 610 (BB5) compliant configurations.

- Maintain efficient operation and low operating costs with precision-cast tandem impellers, multi-vane diffusers and an advanced balance drum design.
- Reduce downtime and maintenance with a standard cartridge-type inner element that allows major assembly and disassembly in the workshop, rather than the field.



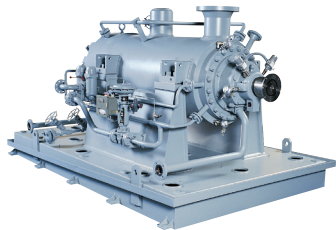

## Byron Jackson HDB high-pressure, double volute, barrel pump

Achieve excellent efficiency, reliability and uptime with this rugged, volute-style barrel pump.

- Ensure hydraulic efficiency with the double volute, opposed impeller construction that balances hydraulic forces over the full operating range.
- Simplify maintenance with a precision-machined axially split inner case that eliminates gasketing and requires only light bolting because it is under hydraulic compression.
- Meet NPSH requirements with a double-suction, first-stage impeller.



## IDP CHTA high-pressure, diffuser-style barrel pump

Realize exceptional reliability with this ASME Section VIII barrel pump designed for the most demanding — and often unspared — high-energy applications.

- Get smooth, consistent operation with precision cast diffusers, which are fully shrouded and 100% NDE inspected, plus low-wear, critical clearance parts.
- Ensure longer uptime and service life with a rugged in-line rotor, short bearing spans and a heavy-duty shaft that improve upset tolerance.



## DMX axially split, multistage BB3 pump

Maximize reliability in high-flow, high-pressure applications with this proven API 610 (BB3) compliant pump (more than 10,000 units supplied).

- Increase uptime with a double volute, opposed impeller design that provides inherent hydraulic balance over the full operating range.
- Get application versatility owing to numerous sizes, materials and options that permit precise configuration.
- Control fugitive emissions with API 682 seal chambers.



## DVSH single-stage, axially split, BB1 pump

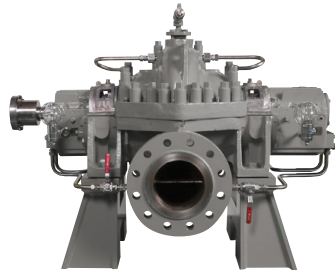

Obtain uncompromising reliability in demanding applications with this heavy-duty pump that is fully compliant with API 610 (BB1) requirements.

- Lower operating costs with pumps precisely selected for best hydraulic fit and efficiency due to comprehensive hydraulic coverage (100+ sizes).
- Achieve high uptime with a double-suction impeller, double volute casing and a heavy-duty shaft, which extend bearing, seal and wear ring life by balancing hydraulic forces and minimizing deflection.

## Worthington LPN single-stage, axially split BB1 pump

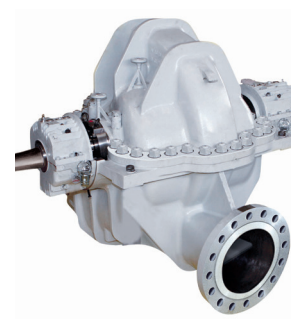

Solve low NPSHA problems for good with this double-suction, medium-pressure pump designed to API 610 (BB1) criteria.

- Extend uptime with the double-suction, double volute design that balances axial and radial hydraulic loads and increases bearing and seal life.
- Control fugitive emissions with API 682 seal chambers.
- Increase MTBR as a result of the heavy-duty bearings and lubrication system.

## Worthington LNN single-stage, axially split pump



Minimize headaches and maximize availability in condensate storage and loading applications with this proven pump that provides high reliability and efficiency with low NPSHR.

- Ensure hydraulic balance and efficiency over the full operating range with the double-suction, double volute design.
- Maximize current and future application flexibility with a pump that boasts more than 200 impeller and volute combinations.

## Worthington LR single-case, axially split pump

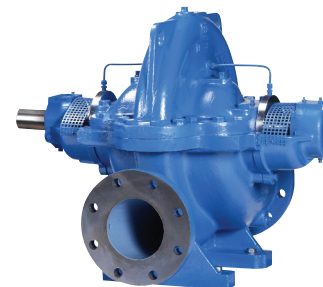

Lower your cost of ownership with this highly reliable and versatile single-stage pump.

- Increase efficiency and optimize performance over a wide flow range, thanks to the low-NPSHR, double-suction impeller and casing wear rings that easily restore operating clearances.
- Make maintenance easier with removable bearing housings and a split-case design that provides easy access to the rotating element without disturbing the piping or driver.





## Vertical pumps

### Worthington WUC double case, vertical VS6 pump



Ensure continuous, unspared duty in critical applications involving high pressures and temperature extremes with this heavy-duty vertical process pump that complies with API 610 (VS6) requirements.

- Achieve reliable cryogenic operation with an available coffer dam system that provides a gas barrier between pumped fluid and the mechanical seal.
- Speed up maintenance with a flanged spacer-type coupling that permits access to the thrust bearings and mechanical seal without disturbing the motor.

### Worthington WUJ vertical wet-pit VS1 pump



Operate unspared in critical services with this highly engineered single-case, vertical pump that meets or exceeds API 610 (VS1) requirements.

- Maximize reliability with an under-critical stiff shaft design, separate axial thrust bearing assembly and pressure-containing parts certified to international standards.
- Precisely configure pumps for application requirements with a choice of radial or mixed-flow hydraulics.
- Maintain operating efficiency with casing and impeller wear rings.

### Worthington ECPJ VS4 sump pump



Achieve dependable performance in tough wet-pit applications with this rugged, single-stage, vertical lineshaft pump that's API 610 (VS4) compliant.

- Precisely match mechanical and hydraulic requirements with the ability to custom engineer each pump for its specific application.
- Get greater reliability and lower inventory costs with a thrust pot design that permits the use of standard (non-thrust) electrical motors.
- Improve low-flow, high-head performance with an available Barske-type impeller.



## VTP vertical turbine pump (VS1)



Ensure cost-effective, consistent performance in wet-pit applications with this versatile, diffuser-style vertical pump; available in single-stage or multistage units as well as general or API 610 (VS1) compliant configurations.

- Get best efficiency fits with comprehensive hydraulic coverage and more than 300 bowl and impeller designs.
- Lower lifecycle costs from available aftermarket rebuild services that revitalize aged pumps — including competitor models — to reduce power consumption, downtime and maintenance costs.

## Worthington QL vertical turbine pump (VS2)



Minimize operating and maintenance issues in difficult wet-pit applications with this double volute, single-stage pump; API 610 (VS2) compliant configuration available.

- Produce higher flows and heads at lower NPSHR with the double-suction impeller.
- Extend uptime with a sealed-for-life bottom bearing plus a heavy-duty discharge head and integral line shaft bracket that ensure shaft concentricity and alignment.
- Maintain operating efficiency with renewable impeller wear rings.

## CPXV single-stage vertical sump pump (VS4)



Ensure efficient and reliable operation with this ISO 5199 compliant vertical sump pump; API 610 (VS4) compliance available.

- Get precisely configured pumps owing to numerous hydraulics, materials, seal types and column lengths, plus many API-compliant options.
- Enhance safety with Category 1 (Zone 0) ATEX configuration for explosive atmospheres beneath the sole plate.
- Ease maintenance with axial adjustment of the heavy-duty thrust bearings made above the sole plate.

## Durco ESP3 chemical sump pump (VS4)



Lower lifecycle and inventory costs with the only vertical immersion sump pump to offer parts interchangeability with an ASME B73.1 pump (Durco Mark 3).

- Reduce operating costs with a reverse vane impeller that provides repeatable high-efficiency performance.
- Optimize configurations with numerous materials, bearing and flush plan options.
- Simplify installation with a standard TCV motor, simplex or duplex pump mounting arrangements, and metal-to-metal fits.





## Overhung pumps

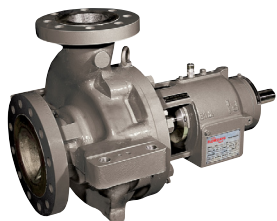

### HPX centerline mounted OH2 pump

Provide unequalled versatility, reliability and safety with this API 610 (OH2) pump — a proven workhorse in the oil and gas industry.

- Lower operating costs with comprehensive hydraulic coverage and specialty configurations that permit precise selection for best operating efficiency.
- Curtail fugitive emissions with a seal chamber that meets stringent API 682 requirements.
- Extend uptime with a centerline-supported casing that exceeds API 610 nozzle load requirements and minimizes shaft misalignment.



### Durco Mark 3 single-stage OH1 pump

Get outstanding performance and low ownership costs in corrosive applications with this proven ASME B73.1 pump.

- Lower lifecycle costs with a reverse vane impeller and external adjustment mechanism, which ease maintenance and renew high-efficiency performance over the pump's life.
- Maximize pump uptime with the ideal seal environment created by the SealSentry™ seal chamber.
- Increase parts standardization and lower inventory costs owing to numerous configurations with high interchangeability.



### Durco Mark 3 ISO single-stage OH1 pump

Realize outstanding performance and low lifecycle costs in corrosive applications with this ISO 2858/5199 compliant process pump.

- Improve efficiency and uptime with a reverse vane impeller and SealSentry seal chamber.
- Simplify maintenance with a two-piece power end and external impeller adjustment mechanism.
- Get broad application versatility and lower inventory costs owing to a wide variety of configurations (sealed and sealless) with high interchangeability.



## IDP MSX solids-handling submersible pump



Reliably handle solids-laden liquids while reducing energy costs with this rugged single-stage pump.

- Lower operating costs with an EPACT-rated motor and high-efficiency hydraulics that reduce energy consumption while providing predictable performance.
- Increase uptime with a dynamically balanced rotor that minimizes vibration and delivers smooth operation.
- Extend the service life owing to a watertight cable entry that protects the motor from moisture and contamination.

## HWMA vertical, inline OH3 pump



Ensure optimal low-flow, high-head performance and low ownership costs with this space-saving, in-line process pump that is fully compliant with API 610 (OH3) requirements.

- Get exceptional efficiency and low-flow stability with a replaceable volute insert and Barske-type impeller.
- Minimize energy costs with a modular design that offers more than 80+ best efficiency point (BEP) fits in a single pump size.
- Simplify maintenance with large openings on the heavy-duty motor support head.



# ACCELERATE YOUR ENERGY TRANSITION

## The right partner throughout your LNG value chain

Today's energy transition calls for a unique balance of driving carbon reduction while also meeting the world's growing energy demands. To do both requires the development and adoption of cleaner, safer and more reliable sources of energy.

That's the critical role LNG will play for years to come. And Flowserve is the ideal partner to help LNG producers thrive during this energy shift:

- Our **broad portfolio** of valves, automation, seal systems and pumps supports companies around the world in diversifying their energy mix.
- Working alongside Flowserve enables companies to **leverage our global resources and engineering expertise** to adopt cleaner sources of energy in the most innovative ways.
- **We've designed, commissioned and supported compressor and pump seals for LNG processes for more than 40 years.** Our proven record with valves, automation and pumps covers more than 225 years. Let's talk about how you can put Flowserve specialists to work alongside your team to engineer and implement the end-to-end solutions that meet your unique needs.









## SOURCES

- <sup>1</sup> Jude Clemente, "Our Climate Fight Begins With Exporting U.S. Natural Gas To Displace Coal," *Forbes*, November 21, 2021, <https://www.forbes.com/sites/judeclemente/2021/11/21/the-climate-fight-begins-with-exporting-us-natural-gas-to-displace-coal/?sh=7705aff75b17> (accessed December 15, 2021).
- <sup>2</sup> U.S. Energy Information Administration, "Natural Gas Explained," December 8, 2021, <https://www.eia.gov/energyexplained/natural-gas/natural-gas-and-the-environment.php> (accessed December 15, 2021).
- <sup>3</sup> Bloomberg, "Carbon neutral LNG: Suppliers focus on optionality, transparency and CCS," April 19, 2021, <https://www.bloomberg.com/professional/blog/carbon-neutral-lng-suppliers-focus-on-optionality-transparency-and-ccs> (accessed December 15, 2021).

---

Flowserve Corporation  
5215 North O'Connor Blvd.  
Suite 700  
Irving, Texas 75039-5421 USA  
Telephone: +1-937-890-5839

Flowserve Corporation has established industry leadership in the design and manufacture of its products. When properly selected, this Flowserve product is designed to perform its intended function safely during its useful life. However, the purchaser or user of Flowserve products should be aware that Flowserve products might be used in numerous applications under a wide variety of industrial service conditions. Although Flowserve can provide general guidelines, it cannot provide specific data and warnings for all possible applications. The purchaser/user must therefore assume the ultimate responsibility for the proper sizing and selection, installation, operation, and maintenance of Flowserve products. The purchaser/user should read and understand the Installation Instructions included with the product, and train its employees and contractors in the safe use of Flowserve products in connection with the specific application.

While the information and specifications contained in this literature are believed to be accurate, they are supplied for informative purposes only and should not be considered certified or as a guarantee of satisfactory results by reliance thereon. Nothing contained herein is to be construed as a warranty or guarantee, express or implied, regarding any matter with respect to this product. Because Flowserve is continually improving and upgrading its product design, the specifications, dimensions and information contained herein are subject to change without notice. Should any question arise concerning these provisions, the purchaser/user should contact Flowserve Corporation at any one of its worldwide operations or offices.

©2022 Flowserve Corporation. All rights reserved. This document contains registered and unregistered trademarks of Flowserve Corporation. Other company, product, or service names may be trademarks or service marks of their respective companies.