

Mixerpac 2563

Installation and Maintenance Instruction for Machinery Parts

To seal*

Machine manufacturer :
Machine type :
End user :
Plant :
Works standard :
Drawing number :
Article ident number :

Table of contents

1.0	Drawing, brief description, function
2.0	Information on safety
3.0	General
4.0	Transport, storage
5.0	Preparing for installation
6.0	Installation
7.0	Connecting the seal support system
8.0	Starting up the machine
9.0	Shutting down the machine
10.0	System check
11.0	Maintenance, replacement parts, aftersales service
12.0	Annex

IMPORTANT!

CAREFULLY READ AND OBSERVE THESE INSTALLATION AND MAINTENANCE INSTRUCTIONS FOR MACHINERY PARTS AND THE SAFETY INSTRUCTIONS BEFORE HANDLING OR STARTUP OF THE MACHINE

FIELD OF OPERATIONS AND PERMITTED USE

The FLOWSERVE Mixerpac 2563 is intended exclusively for the installation on mixer vessels. All other instances of use are not permissible. The manufacturer is not liable for any damage incurred through non-permitted use; the risk is borne by the customer alone.

* Should details based on the order not be given, the user shall be responsible for the assignment according to permitted use.

1. Drawing, Brief Description, Function

See the annex for the installation drawing.

1.1 Specifications for the operations described herein:

Application limits:

Product pressure (bar)	Vacuum / 16 ¹⁾ Vacuum / 10 ²⁾ 6 ³⁾
Max. barrier pressure (bar)	18 ¹⁾ 12 ²⁾
Test press. barrier chamber (bar)	21 ^{1) / 4)} 14 ^{2) / 4)}
Speed (m / s)	4 based on d ₃
Product temperature (°C)	-20 / +200 -20 / +300 ⁵⁾

1) Shaft - $\varnothing d_3 \leq 100$ mm

2) Shaft - $\varnothing d_3 > 100$ mm

3) Operation with unpressurized quench system

4) statically, $v = 0$ m/s

5) Design with additional cooling flange

The application limits specified are maximum load values and assist in preselection. The application limits must be checked for every application.

A warranty in an individual case is possible only when FLOWSERVE knows the exact application conditions and these have been confirmed in a separate agreement.

1.2 Brief description

The Mixerpac 2563 is delivered as a complete, bidirectional and ready-to-install seal-ing cartridge. It seals the product chamber of a mixer vessel from the atmosphere. It comprises a multiple mechanical seal (MS) with axially arranged seal ring pairs, on the product side as well as on the atmospheric side an unbalanced seal, a shaft sleeve, housings and optional with an installed cooling flange.

- 1.3 The spring force and the product pressure push the seal ring against the mating ring. The seal ring and the mating ring is sealed from the shaft sleeve, respectively from the housing, by sealing elements (e. g. O-rings). The faces of the seal ring and the mating ring are designed as sealing faces and establish the seal gap. On the product side, the MIXERPAC has a MS with self-sealing effect in both directions, i. e. it seals both from the product side and from the barrier fluid side. In the event of loss or of variations the product-side MS remains closed (safety case).

Up to a pressure difference of $\Delta p = 6$ bar the MIXERPAC can be run with an unpressurized quench fluid (no danger of dry friction when the lubricating film ruptures).

1.4 Function

- ! The barrier medium introduced in the barrier chamber must exhibit a pressure of 1-2 bar higher than the product in the mixer vessel.
- ! Up to a pressure difference of $\Delta p = 6$ bar the MIXERPAC can be run with an unpressurized quench fluid (no danger of dry friction when the lubricating film ruptures).

This causes the barrier fluid to form a seal film in the seal gaps, preventing product from escaping into the atmosphere.

The fluid must always be present at the seal gaps, so that a seal film can be generated. The seal film exists when the shaft is stationary.

The seal faces of the seal rings and the mating rings are separated from each other by the film during shaft rotation and function without contact and wearing under these conditions.

The choice of the barrier or the quench fluid depends on the respective use and must be matched to the affected systems. In all cases a clean barrier or quench fluid must be used.

The consumption of the barrier or the quench fluid depends on the respective operating data. The consumed quantity of barrier or quench fluid enters the product through the product-side seal gap and the atmosphere through the atmospheric-side seal gap, where it is drawn off through connection C.

- ! The product pressure may not exceed the values given under item 1.1.

1.5 Function conditions





The MIXERPAC's function is obtained only when the following conditions are fulfilled:

- Filtered barrier or quench fluid (filter mesh $< 5 \mu\text{m}$) supplied at connection A.
- Plane-lapped seal faces.
- Perpendicularity between the seal faces and the shaft centerline.
- Unforced clearance of the rotating parts within the specified tolerances.
- Prevention of sedimentation on the surfaces of the shaft or shaft sleeve by e. g. crystalliation or polymerisation.
- Prevention of the product from adhering in the area at the seal gaps.
- Permanent fluid film in the seal gaps.
- Adherence to the specified operating data as per item 1.1 respectively the data sheet.

If these function conditions are not fulfilled, the consumption of barrier or quench fluid is increased and parts of the product can escape into the atmosphere. Additionally, disregarding of these issues can result in high component temperatures.

! See the Directive 94/9/EC. EN 13463, Part 1 - 8.

2.0 Information on Safety

- 2.1  **DANGER:** This symbol means, that failing to observe this information involves the risk of personal injury and / or considerable damage to property.
- ! **IMPORTANT:** This symbol draws your particular attention to important information that is possibly not clear even to qualified personnel. This information, however, must be observed to prevent malfunctions that in turn could directly or indirectly give rise to serious injury and / or property damage.
- 2.2 The customer and / or the operator must ensure that all persons assigned to handle, assemble or operate the machine have carefully read these installation and maintenance instructions, before they commence any installation and maintenance work at the MIXERPAC or before operate the machine. These personnel must be fully acquainted with the layout and function of the MIXERPAC and the respective support system.
- 2.3  Damage may cause leakage in liquid or gaseous form. The hazardous effects correspond to those of the product, and there may be hazard to persons or the environment. The operator's regulations concerning work safety, accident prevention, and pollution for this plant section must be adhered to without exception.
- 2.4 ! Components coming into contact with the leakage must be corrosion-resistant or corrosion-proof.
- 2.5  If the application of the MIXERPAC requirements is subject to the ATEX 94/9/EC, then it is also imperative to comply with the annex for the assembly and maintenance instructions of the ATEX 94/9/EC guidelines.
- 2.6 ! MIXERPACs must be decontaminated before they are sent to FLOWSERVE for maintenance or repair.
- 2.7 ! When employing elastomers of EP (ethylene-propylene) or butyl rubber, do not use any grease or oil on a mineral basis as a barrier or quench fluid.
- 2.8  A loss, a re-establishment or a change of the power supply for the machine and / or the barrier system may not impair the properties of the MIXERPAC and / or involves a risk of personal injury and / or considerable damage to property.
- 2.9  Assigned protection devices from the machine manufacturer must be accordingly



arranged and may no cause additional endangerments. They must ensure the necessary range for the accessibility to maintenance work to the MIXERPAC.

- 2.10  The electrical supply of the machine must correspond to the protection targets of the Directive 2006/95/EC.
No endangerments for persons and environment may proceed from a non electric power supply.

3.0 General

- 3.1 All illustrations and details in these operating instructions are subject to technical alterations that are necessary in improving the MIXERPAC.
- 3.2 The copyright on these installation and maintenance instructions is the property of FLOWSERVE. These installation and maintenance instructions are intended for the assembly, operating, and supervisory personnel and contain regulations and drawings of a technical character that may not, in full or in part, be copied, distributed, used without authorization for competitive purposes, or given to others.
- 3.3 We point out that we accept no liability for any instances of damage or malfunctions of the machine incurred through nonadherence to these installation and maintenance instructions.

4.0 Transport, Storage

- 4.1 The MIXERPAC must be transported and stored in the unopened original packaging. The storage site must be dry and free of dust. Influences through temperature or irradiation must be avoided.
- 4.2 Parts or complete MIXERPACs that have been dropped or otherwise subjected to heavy impacts during transport must not be installed. An inspection by FLOWSERVE becomes necessary.
- 4.3 After a storage period of three years the MIXERPAC must be inspected for properties as new. This applies in particular to the secondary seals and seal faces. We recommend an inspection by FLOWSERVE.
- 4.4  If the machine is to be preserved with integrated MIXERPAC the preserving medium must not impair the function of the MIXERPAC by e. g. fouling or hardening or swelling the secondary seals.
- 4.5  The MIXERPAC must be transported with adequate tools, e. g. by using industrial trucks or lifting devices.

5.0 Preparing for Installation

- 5.1 **!** The MIXERPAC may be installed when there are no visible signs of damage to the MIXERPAC. This applies in particular to the static faces of the MIXERPAC flange, centrings and the static sealing elements.
- !** Before installing, consult the specifications on the accompanying documents to verify that the correct MIXERPAC has been installed correctly and is suitable for the specified application. Do not exceed the design data.
- !** Requisite for all assembly work are the installation drawing and parts list and the tools and aids required for the assembly.
- !** Dismantling the MIXERPAC is not permitted without the written consent of FLOWSERVE and will lead, without special tools, to damage.
- !** Vibrations must not be allowed to reach the installed MIXERPAC when the machine is operating or in particular when it is shut down. Vibrations can be stopped e.g. by structural measures on the machine.
- 5.2 **!** The installation chamber for the MIXERPAC must be checked against the corresponding drawing and table of dimensions so that the Mixerpac is in accordance with these instructions. It must be ensured that all dimensions, surface qualities and tolerances (e.g. concentricity, runout, fits) are observed. The specifications under e.g. ISO 21049 or API 682, DIN 28161, FLOWSERVE publications FSD101 respectively FSD127 must be observed.
- 5.3 Ensure the highest degree of cleanness. Force must not be used to install the seal. Use only suitable tools and devices.
- 5.4 The seal faces of the MIXERPAC are important functional sections and may not be damaged.
- 5.5 All functional and assembly areas for the secondary seals (e.g. O-rings) must be dimensionally accurate, free of scratches and burrs, flash-free and rounded.
- 5.6 The fitting surfaces of the MIXERPAC and the installation chamber must be undamaged and the feed pipes and ring channels dry. Ensure the highest degree of cleanness.
- 5.7 A thin coat of product-compatible grease (e. g. Molykote M55) is to be applied to the sealing elements. Excess grease is to be avoided.
- 5.8 Depending on the installation direction, a lubricant, (e. g. Molykote D321R) or PTFE spray without solvent, must be applied to the shaft or shaft sleeve.
- !** The areas for the clamp-connections must remain free of grease, otherwise the adhesive force will become inadequate for correct functioning.

6.0 INSTALLATION

6.1 The MIXERPAC is installed in the mixer in accordance with the instructions from the machine manufacturer and with consideration to the following recommendations.



The machine to take the MIXERPAC must be earthed in accordance with the applicable regulations for electrical installations (e. g. VDE rules) to conduct away any electrostatic build-up and so prevent spark formation.



Parts of the MIXERPAC, which needs to be entered during assembly works, needs to be secured against slipping, stumbling or falling (e. g. by holding devices).



Installation of the MIXERPAC on the machine may take place during machine breakdown only.

6.2 The MIXERPAC must always be installed with the installation plates engaged.

6.3 Apply a lubricant to the mixer shaft or shaft sleeve, see item 5.8.

6.4 Push and lower the complete MIXERPAC on the mixer shaft.

6.5 Align the MIXERPAC to the positions of the flange and connection bores.

6.6 Continue to lower the MIXERPAC down to the metallic seat in the area of the fastening screws, and then screw this to the mixer vessel.



It is imperative that the centering of the MIXERPAC housing engage in the mixer vessel's assembly flange without force. Under no circumstances may the given fit tolerances be exceeded.



Components provided by the customer for installing the MIXERPAC, e.g. fastening screws, must prove adequate both in the choice of material and the dimensions. It must not be possible to overstress these components, e. g. the max permitted tightening torque must not be exceeded.

6.7 Effect the shrink plate connection between the shaft sleeve and shaft. The shrink plate is stressed as per the installation instructions for shrink plate connections (see item 12.1) over several stages to a tightening torque in accordance with the drawing.



The areas for the clamp connections must remain free of grease, otherwise the holding force will become inadequate for correct functioning.



The shaft sleeve can be displaced in radially or axially direction, if the shrink disc connection between the shaft sleeve and shaft is not accomplished according to the requirements.

6.8 To disengage the installation plates, loosen the screws, pull out the plates and retighten the screws.

- ! The disengaged installation plates may not contact rotating parts during the operation of the machine.

6.9 Once more check the running precision as per DIN 28161 and the installation dimensions according to the assembly drawing.



The installation dimensions of the MIXERPAC must apply to the dimensions shown on the assembly drawing. Non-compliance of the information shown on the assembly drawing may cause in damages.

7.0 Connecting the Seal Support System

7.1 The MIXERPAC is connected by pipes to a seal support system in accordance with the specifications from the machine manufacturer. The connecting pipes must be of rust-free material and have an internal diameter of at least 15 mm.

7.2 First remove the plastic plugs from the connection bores A and B of the MIXERPAC, as well from the connections E and F of the optional installed cooling flange.



The connections on the MIXERPAC and the optional installed cooling flange are marked accordingly.

7.3 Connect the feed pipe of the seal support system to connection A and the return pipe to connection B. The cooling lines are connected at the sites marked E and F respectively on the optional installed cooling flange.

The required flow rate for the cooling medium depends on the respective operating conditions. The flow rate should be between 300 and 600 l/h and must allow adjustments in line with the respective operating conditions.

- ! Forced ventilation must be ensured when pipes are connected to the connections A and B. If gas or air bubbles should become trapped in the barrier or quench fluid chamber, these can collect at the outside diameter of the seal gap when the mixer starts to rotate. This causes the machine to run dry at the seal gap for an indefinite period, and the seal faces can become damaged.

- ! We recommend monitoring the liquid circulation to maintain the conditions for correct MIXERPAC running.

- ! Suitable measures must be implemented to prevent errors in the operation of shut-off and throttling devices installed in the fluid supply.

- ! Up to a pressure difference of $\Delta p = 6$ bar the MIXERPAC can be run with an unpressurized quench fluid (no danger of dry friction when the lubricating film ruptures).

7.4 Slowly fill the MIXERPAC and the seal support system with barrier or quench fluid

through the feed pipe. Carefully vent at the highest site.

- 7.5 A check can now be conducted on the mixer's sense of rotation (without pressurized seal support system).
- 7.6 The MIXERPAC run with unpressurized quench fluid the product-side leakage fills the quench circuit when the mixer vessel is flooded with product up to the seal face. For this reason an adequate overflow protector (e. g. level switch) must be provided. When the applied product on the product-side seal face is gaseous, this gas enters the seal support system, too. In both cases a forced ventilation of the seal support system must be ensured.

8.0 Starting Up the Machine

- ! Disengage setting plates of the MIXERPAC before start up the machine (see item 6.8).
- ! Parts of the MIXERPAC, which rotate during operation of the machine, must be secured against contacts, in accordance with the specifications from the machine manufacturer.

- 8.1 The MIXERPAC is ready for operation of the machine, after it has been installed, the seal support system connected, the sealing chamber carefully vented and feeding cooling medium into the optional installed cooling flange if applicable.

! It must be ensured that the sealing chamber is completely filled with barrier or quench fluid and vented in every operating situation of the machine so as to minimize frictional heat leading to increased temperature of the surfaces.

! The required flow rate for the cooling medium depends on the respective operating conditions. The flow rate should be between 300 and 600 l/h and must allow adjustments in line with the respective operating conditions.

- 8.2 The installed MIXERPAC is bidirectional.

- 8.3 ! The sealing chamber must be vented carefully before startup of the machine.

- 8.4 For the static pressure test on the product vessel the barrier pressure must be equal to or higher than the vessel pressure and may not exceed the values given under item 1.1.

- 8.5 To check the unchanged position of the shaft sleeve after the pressure test of the product vessel, engage an installation plate. Afterwards, the installation plate must always be disengaged as per item 6.8.

- 8.6 The barrier or quench fluid should preferably be oil and must have a kinematic viscosity between 1 and 50 mm²/s (cSt) during operation of the machine. Water or other media with low boiling points (e. g. methanol) are also possible. In the case of fluids with low boiling points used as barrier or quench fluid, a hard / soft material combi-

nation must be selected for the faces.

- ! The choice of the seal support system must accommodate for the viscosity of the barrier or quench fluid employed.

The barrier or quench circuit must undergo forced circulation and / or adequate cooling to carry off heat so that the viscosity of the fluid does not fall below this limit. The required viscosity of the barrier or quench fluid can be attained by external heating so that this viscosity limit is not exceeded; this particularly applies when only the thermosiphon effect generates the circulation of the barrier or quench fluid.

- ! To prevent damages on seal parts FLOWSERVE must be consulted on any deviations with respect to the barrier or quench fluid's viscosity.

- 8.7 Frictional heat can be dissipated and deposits around the seal faces prevented only when adequate circulation is provided for the barrier or quench fluid (e. g. by forced circulation).

- ! At all operating temperatures the barrier or quench fluid must not come within 20 K of its evaporating point. Should this not be the case during certain operating situations (e. g. mixer shutdown, start-up) forced circulation or adequate cooling of the barrier or quench circuit must be generated to promote heat removal.



Temperatures at the housing surfaces of the MIXERPAC correspond to the operating temperatures of the product, respectively the barrier or quench fluid. Suitable precautions against contacts are necessary.

- 8.8 The MIXERPAC is ready for operation of the machine, after the seal support system is filled with either pressureless quench fluid or if the barrier circuit is pressurized with 1 - 2 bar higher than the product pressure which needs to be sealed. (see item 1.5).

- ! The MIXERPAC will be damaged when the conditions given under item 1.5 are not maintained.

- ! The MIXERPAC operate with unpressurized quench fluid the product-side leakage fills the quench circuit when the mixer vessel is flooded with product up to the seal face. For this reason an adequate overflow protector (e. g. level switch) must be provided. When the applied product on the product-side seal face is gaseous, this gas enters the seal support system, too. In both cases a forced ventilation of the seal support system must be ensured. The leakage of quench fluid then corresponds in its properties to the composition of the product. Instructions and regulations concerning safety measures and protective clothing must be observed and adhered to according to the plant section.

- ! Follow the instructions both for start up and re-commissioning of the machine after a machine breakdown, see items 8.0 to 8.8.

8.9 Possible malfunctions:

SYMPTOM	CAUSE
Dramatic loss of barrier or quench fluid	<ul style="list-style-type: none"> - Shaft rotates eccentric. - Pipe connection leaks. - Defect barrier pressure setting. - Damage at the mechanical seal (barrier or quench fluid enters the product vessel). - Damage at the shaft seal on the atmospheric side (barrier or quench fluid leaks from connection C).
Barrier pressure increases	<ul style="list-style-type: none"> - Defect barrier pressure setting. - Barrier fluid volume expands owing to heating (Cooling or forced ventilation of the barrier or quench fluid circuit not adequate).
Barrier or quench fluid temperature increases	<ul style="list-style-type: none"> - Insufficient dimensioning for the cooling of the seal support system. - Barrier pressure too high. - Lack of barrier or quench fluid.

8.10 The mixer shaft may be stopped at any time.

! The MIXERPAC cannot function during all assembly and maintenance work.

9.0 Shutting Down the Machine and Mixerpac Removal

9.1 The machine can be shut down at any time under normal conditions; please note the pressure conditions (see item 1.5).

9.2 Before the MIXERPAC can be removed the machine must first be shut down and the mixer vessel and seal support system depressurized.

9.3 The shaft may be shut down under pressurized conditions.

9.4 Remove the MIXERPAC by following the instructions for installation in reverse order.

 Removing the MIXERPAC from the machine may take place during machine breakdown only.

! The MIXERPAC must always be removed with the installation plates engaged.

 Temperatures at the housing surfaces of the MIXERPAC correspond to the operating temperatures of the product, respectively the barrier or quench fluid. Suitable precautions against contacts are necessary.

9.5 To engage the installation plates, loosen the screws, pull the plates into the shaft sleeve groove, and retighten the screws.

 Removing the seal may release product, respectively barrier or quench fluid! All information and regulations regarding safety measures and protective clothing with respect to this plant section must be observed and strictly adhered to. The operator must ensure the proper disposal of the media collected when the machine is vented or drained.

9.6 Carefully replace the removed MIXERPAC in the original packaging (e. g. wooden crate) and store or send this to FLOWSERVE for inspection.

9.7  Follow the instructions for recommissioning of the machine, after a machine breakdown, see items 8.0 to 8.8.

10.0 System Check

 System check of the MIXERPAC may take place during machine breakdown only.

 Ensure accessibility for the necessary range to operate the machine or for maintenance work at the MIXERPAC.

10.1 System checks of the MIXERPAC extend to the monitoring of the set values for pressure, temperature and barrier or quench fluid consumption.

10.2 Removing the MIXERPAC for an inspection becomes necessary when:

- The specified leakage values are exceeded and, after enquiries at FLOWSERVE, no other written agreement ensues.

 Examination of the leakage rates should take place at least once during 24 operating hours!

- After an installation period of more than three years.
- An inspection of the mixer is due, and a similarly long operating period is expected thereafter.

11.0 Maintenance, Replacement Parts; Aftersales Service

11.1 Repairs must be conducted by FLOWSERVE within the guarantee period. In special cases (emergencies) competent personnel may replace individual parts in situ after consultation with FLOWSERVE.

 Decontaminate the MIXERPAC and return it to a FLOWSERVE authorized repair facility with an order marked „Repair“ or „Replace“.

A signed certificate of decontamination must be attached. A Material Safety Data Sheet (MSDS) must be enclosed for any product that came in contact with the

MIXERPAC. The MIXERPAC will be inspected and if repairable, a quotation will be made for restoring it to its original condition. Upon acceptance of the quotation, the MIXERPAC will be rebuilt, tested and returned to sender.

- 11.2 ! Replacement parts are to be ordered with the ID numbers given in the annexed parts list.
- 11.3 ! A warranty is given only for the original replacement parts delivered by FLOWSERVE. All parts of the MIXERPAC meet with high-precision dimensional tolerances and are matched to one another. Only a part replacement as given in the FLOWSERVE quality assurance documentation ensures smooth operation.
- 11.4 ! We expressly point out that original replacement parts and accessories not delivered by FLOWSERVE are not tested or released by FLOWSERVE. Under certain circumstances therefore, using and / or installing such products may impair the properties given in the MIXERPAC design and hence undermine the active and / or passive safety. All incidents of damage incurred through the use of non-original replacement parts or appurtenances render all liabilities and warranties on the part of FLOWSERVE void.

Please note that special manufacturing and delivery specifications exist for all parts of our products manufactured or procured by ourselves, and the replacement parts are always offered in accordance with the latest technology and with the most current regulations and laws.

12.0 ANNEX

12.1 Mounting and Removal Instructions for Shrink Discs

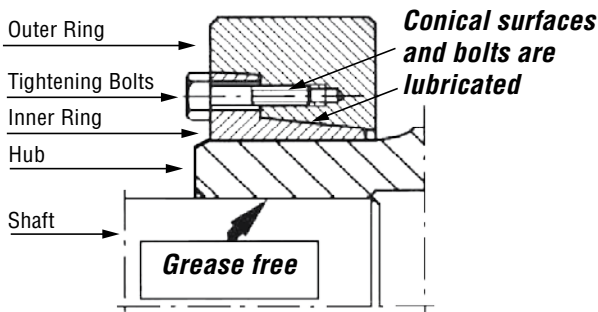

Mounting

The shrink discs are supplied ready to be mounted. Therefore they should not be dismantled prior to employing the unit for the first time.

1. Degrease shaft and hub bore!

2. Slide shrink disc onto hub. The outer surface of the hub may be greased outside the shrink disc fit.

CAUTION!

Do not tighten the tightening bolts before the shaft is mounted.

3. Fit the shaft or slide the hub onto the shaft.
4. Tighten all tightening bolts uniformly, one by one, over several revolutions until the outer ring and inner ring are flush. This indicates that the full transmissible torque is achieved.
5. Check each tightening screw twice for the required tightening torque.

Dismounting

This is similar to mounting.

1. Loosen all tightening bolts, initially not more than a quarter turn per bolt, one after one.

CAUTION!

Under no circumstances should the locking bolts be completely removed as this could be dangerous and result in injury.

2. Should the outer ring, when loosening the bolts, not slide automatically from the inner ring, this can be assisted by removing those locking bolts adjacent to the tapped bores provided for jacking purposes and screwing them into these. The jacking procedure must be continued until a complete release of the outer ring is achieved.
3. Dismount shaft or draw off hub. Remove rust which may have formed on the shaft in front of the hub.
4. Remove shrink disc from hub.

Cleaning and lubrication

Dismounted shrink discs do not have to be dismantled and relubricated before remounting. The shrink disc has to be cleaned and relubricated only if employed in dirty environment.

Use a solid containing lubricant (paste) with a high content of MoS₂ and a coefficient of friction of $\mu = 0,04$ to lubricate the conical surfaces as well as bolts.

Lubricant examples:

Molykote D-321 R (Bonded coating)	Dow Corning
Molykote G Rapid + Paste	Dow Corning
M Aema-Sol MO 84-K (Bonded coating)	A.C.Matthes
Aemasol MO 19 P Paste	A.C.Matthes

12.2 Assembly drawing, parts list.

44388 Dortmund,	03-17-1997	DO	Rev. 0	02-08-2005	LI	Rev. 4
	12-21-2001	DO	Rev. 1	12-23-2009	BE	Rev. 5
	03-11-2003	LI	Rev. 2	05-10-2010	LI	Rev. 6
	03-10-2004	LI	Rev. 3			



TO REORDER REFER TO
B/M or Assy. # _____
Order # _____
Seal Type _____

FIS205eng REV 07/10 Printed in Europe

***To find your local Flowserve representative
and find out more about Flowserve Corporation,
visit www.flowserve.com***

Flowserve Corporation has established industry leadership in the design and manufacture of its products. When properly selected, this Flowserve product is designed to perform its intended function safely during its useful life. However, the purchaser or user of Flowserve products should be aware that Flowserve products might be used in numerous applications under a wide variety of industrial service conditions. Although Flowserve can provide general guidelines, it cannot provide specific data and warnings for all possible applications. The purchaser/user must therefore assume the ultimate responsibility for the proper sizing and selection, installation, running, and maintenance of Flowserve products. The purchaser/user should read and understand the Installation Instructions included with the product, and train its employees and contractors in the safe use of Flowserve products in connection with the specific application.

While the information and specifications contained in this literature are believed to be accurate, they are supplied for informative purposes only and should not be considered certified or as a guarantee of satisfactory results by reliance thereon. Nothing contained herein is to be construed as a warranty or guarantee, express or implied, regarding any matter with respect to this product. Because Flowserve is continually improving and upgrading its product design, the specifications, dimensions and information contained herein are subject to change without notice. Should any question arise concerning these provisions, the purchaser/user should contact Flowserve Corporation at any one of its worldwide operations or offices.

USA and Canada

Kalamazoo, Michigan USA
Telephone: 1 269 381 2650
Telefax: 1 269 382 8726

Europe, Middle East, Africa

Dortmund, Germany
Phone: +49 231 69640
Telefax: +49 231 6964-248

Asia Pacific

Singapore
Telephone: 65 6544 6800
Telefax: 65 6214 0541

Latin America

Mexico City, Mexico
Telephone: 52 55 5567 7170
Telefax: 52 55 5567 4224

© Copyright 2010 Flowserve Corporation