

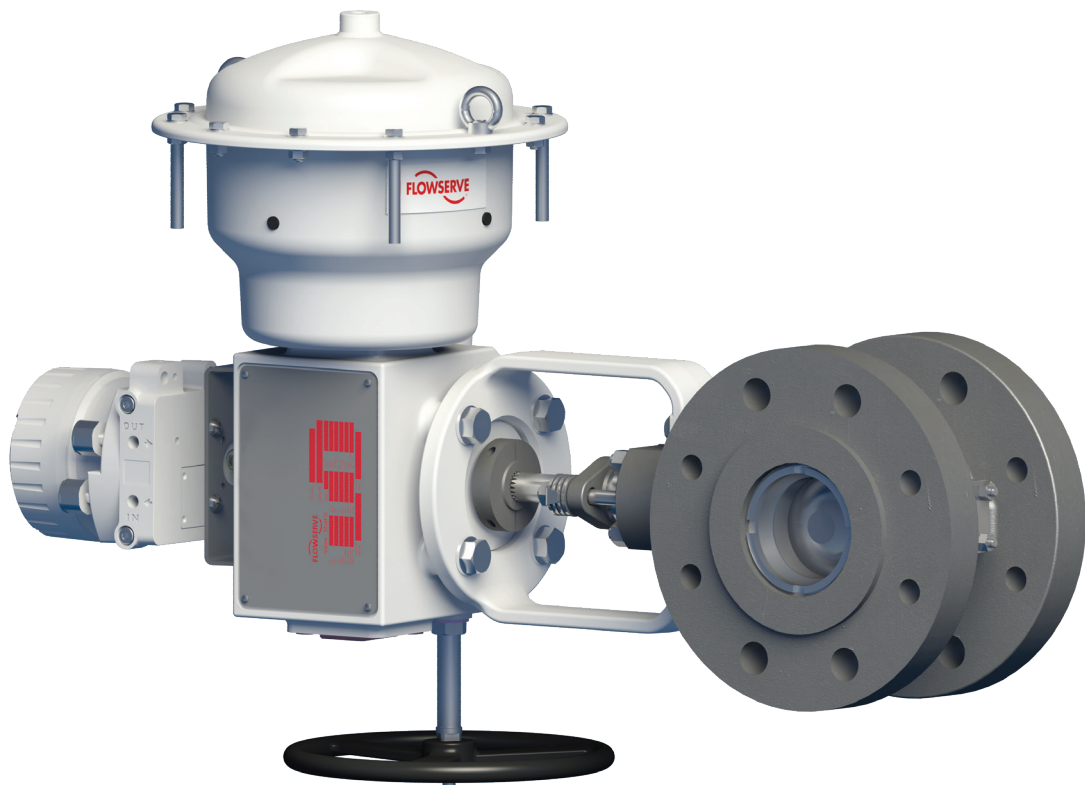

## USER INSTRUCTIONS

*Installation*  
*Operation*  
*Maintenance*

# Valtek® MaxFlo 4™ Eccentric Rotary Plug Control Valve



*Experience In Motion*

## Valtek® MaxFlo 4™ Control Valve

The Valtek® MaxFlo 4™ control valve is a rugged, compact, lightweight valve used in a wide range of applications plant-wide. Its modular design provides trim and material options to suit most service situations. Simplicity of design reduces maintenance and parts inventory costs. It is ideally suited for flow and pressure control of liquid and gas media in oil and gas, power, chemical and petrochemical processing and related industries. The MaxFlo 4 control valve package provides flow rates, control accuracy and reliability at levels comparable to special engineered service control valves, but at a significantly lower cost. The MaxFlo 4 is manufactured to ISO 9001 standards. The following instructions are designed to assist in unpacking, installing and performing maintenance as required on Flowserve MaxFlo 4 control valves. This instruction manual does not include specific product design data. Such data can be found on the valve's serial plate or specification documents; additionally, dimensional information can be found in the MaxFlo 4 technical bulletin. Procure needed documents as necessary before you begin any work on the valve.



Figure 1: MaxFlo 4

User Instructions cannot deal with all possible situations and installation options. It is required that only trained and qualified technicians are authorized to adjust, repair or work on control valves, actuators, positioners and other accessories. Review this bulletin prior to installing, operating or performing any maintenance on the valve. Additional Installation, Operation, and Maintenance Instructions (IOMs) cover other features (such as special trim, actuators, handwheels, packing and positioners).

To avoid possible injury to personnel or damage to valve parts, WARNING and NOTICE indicators must be strictly followed. Modifying this product, substituting non-factory parts or using maintenance procedures other than outlined could drastically affect performance and be hazardous to personnel and equipment and may void existing warranties. This manual should be used in conjunction with applicable local and national laws. Failure to comply with User Instructions will render the manufacturer's guarantee and liability null and void. Unless otherwise agreed, the manufacturer's general terms and conditions of sale shall apply.

**Read the user instructions carefully before use.  
Keep for future reference.**

### Contents

1	Scope of Manual	3	10	Valve Quick-Check	7 – 8
2	Intended Use	3	11	Valve Maintenance	8 – 9
3	Product Identification	3	12	Troubleshooting	10 – 11
4	MaxFlo 4 Modification	3	13	Disassembly and Reassembly	12 – 15
5	Safety	4	14	Disposal	15
6	Packaging and Transport	4			
7	Storage	4			
8	Unpacking	4			
9	Installation	5 – 6			

## 1 Scope of Manual

The following user information covers the MaxFlo 4 general service control valve:

- DIN Units – PN 10-63, DN 25-300
- ASME Units – Class 150 – 600, NPS 1 – 12
- Assembled with a pneumatic actuator
- Comes with or without ancillary equipment

## 2 Intended Use

**⚠ WARNING** Control valves are pressure vessels designed and rated for specific application conditions. Before installation, check the serial number and / or the tag number to ensure that the valve and actuator being installed are correct for the intended application. Do not use the valve outside of its rated design limits. Exceeding the design limits may cause hazardous conditions including leakage of the process media or rupture of the pressure boundary resulting in possible process loss, equipment or environmental damage, or serious personal injury or death.

The specific product design data can be found on the valve's serial plate, data sheet and the calculation sheet (in acc. to the IEC 60534-7:2010).

The MaxFlo 4 handles a wide variety of applications, while offering high flow capacity. Restricted trim and noise reduction plates available as an option.

The MaxFlo 4 consists of the body, bonnet, trim, transfer case and actuator. The valve is designed with a high level of interchangeability allowing the user to assemble the greatest possible number of variations from a minimum number of components to match each application.

The MaxFlo 4 is designed for use in ambient temperature range -40°F to 158°F (-40°C to 70°C), air humidity up to 93% non-condensing, air pollution up to 300 µg/m<sup>3</sup>, unless restricted by the accessories.

The product offering may include optional ancillary equipment, such as positioners, air-filter regulators, solenoid valves, limit switches or boosters. Digital, I/P, or pneumatic positioners can be mounted directly, with a mounting bracket or according to NAMUR standards. Refer to the relevant manufacturer's user instructions for information regarding other ancillary equipment.

## 3 Product Identification

Each MaxFlo 4 control valve comes with an attached serial plate which includes key information specifically for each control valve:

The serial plate is a rectangular form with the following fields: MODEL, SIZE, PRESS. RATING, TRIM/CV, SIGNAL, AIR TO, FAIL, S/N, TAG, CHAR, PO, BODY, PLUG HEAD/DISK/BALL, SEAT. There are also two small circles on the left and right sides of the form.

Figure 2: Valve Serial Plate

The same serial number shown on the plate will appear on all MaxFlo 4 data sheets, dimensional drawings, bills of material, and spare parts lists. Other information located on the serial plate is self-explanatory for the MaxFlo 4 control valve.

You can download .pdf versions of the MaxFlo 4 documentation including a sales brochure, technical bulletin and user instructions at [www.flowserve.com](http://www.flowserve.com). It is the user's responsibility to keep this and related documentation on file and accessible for the MaxFlo 4 product.

## 4 MaxFlo 4 Modification

MaxFlo 4 control valves are generally delivered as tested and assembled units, with factory-mounted actuators.

**Unauthorized modification of the MaxFlo 4 control valve voids the product test certification and product warranties, could drastically affect product performance, and could be hazardous to personnel and equipment.**

**NOTICE** Before MaxFlo 4 re-use, all necessary tests must be repeated and recorded in compliance with all test routines, guidelines and engineering standards.

## 5 Safety

Safety terms - WARNING and NOTICE - are used to highlight specific dangers and / or provide additional information that may not be readily apparent in the User Instructions. WARNING directions must be strictly followed.

**WARNING** or **WARNING** indicates that severe personal injury, death and substantial property damage can occur if proper precautions are not taken.

**NOTICE** NOTICE indicates practices or provides additional technical information.

Grey fields indicate safety-related informations.

## 6 Packaging and Transport

Pay close attention to shipping marks and transport pictograms.

Careful packing, loading and transport arrangements are required to prevent products from being damaged during transport. Standard packaging includes a cardboard box, with or without a wooden pallet base as needed. Special packaging may include a wooden box. Packaging may use cardboard, plastic wrap, foam, or paper as packing material. Filling material may be a carton type or paper.

Shipping marks display product and package dimensions and weight (for further information see Packaging and Sending Instructions, Form L 002). Packing guidelines for export follow HPE standards. (Nonreturnable packaging may contain up to 90% recyclable materials.)

## 7 Storage

Maximum storage time for control valves is six months.

**NOTICE** The packing box begins to break down after 6 months. Leakage may develop.

Upon arrival on site, store the MaxFlo 4 on a solid base in a cool, dry closed room. Until its installation, the valve must be protected from the weather, dirt and other potentially harmful influences.

Do not remove the protective covers from the body flanges of the control valve or from the instrument ports of the actuator and accessories until the valve is ready for installation at the site.

## 8 Unpacking

Hoisting and lifting are inherently dangerous activities and require safe rigging and proper training to mitigate hazards. Use standard industry safety practices, personal protection, and warranted lifting devices.

**WARNING** Crushing hazard ! Arrange rigging to prevent tipping of the control valve. Do not allow the valve assembly to rotate during removal. Do not stand under suspended loads. Failure to do so can cause serious personal injury and damage the valve or nearby equipment.

**NOTICE** Be aware that the center of gravity may be above the lifting point. Do not allow the sling to touch the stem or peripheral equipment. Observe the maximum permitted carrying capacity.

1. Check the packing list against materials received to ensure all components and accessories are present.
2. When lifting the valve from the shipping container, use straps through the yoke legs. Take care to position lifting straps to avoid damage to the tubing and mounted accessories.

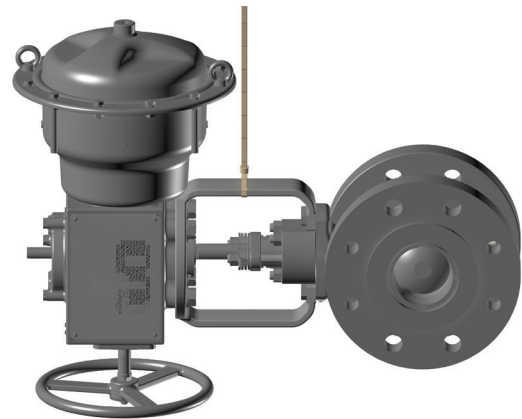

3. Upon removing the control valve from the packaging, we recommend that you:
  - Promptly touch up any damage to the corrosion protection.
  - Contact your shipper immediately to report any damage.
  - Call your Flowserve representative if you experience any problems.
  - Do not remove the protective covers from the body flanges of the control valve or from the instrument ports of the actuator and accessories until the valve is ready for installation at the site.

## 9 Installation

**The control valve must be installed and commissioned by qualified staff — personnel who are familiar with the installation, commissioning and operation of this product and possess the relevant qualifications in their field of activity.**

**! Prior to installation of the valve, we require, that you check the following conditions to reduce the risk of malfunction and safety-related incidents.**

No.	Check	Possible malfunction or safety-related incident
1	Confirm that the nominal / operational data on the serial plate matches the operational data of the facility.	<i>An operational mismatch can cause considerable damage to the valve or may lead to a failure at the facility.</i>
2	Confirm that the line is clear of dirt, welding slag, chips, scale or other foreign material.	<i>The risk of control valve damage due to foreign particles will be reduced if a suitable strainer is installed upstream of the valve. (Suggested mesh size of 0.004 inch (0.1 mm))</i>
3	Confirm the piping flanges are coaxial, parallel, and correspond with the face-to-face dimension of the valve.	<i>Incompatible sizing may result in excessive tension, valve malfunction or flange connection leakage.</i>
4	Confirm the piping is routed correctly and the valve is free of additional piping forces.	<i>Incorrect routing may result in leakage and / or potential valve failure.</i>
5	Refer to the MaxFlo 4 technical brochure for proper clearances	Not enough clearance will make disassembly and repairs more difficult.
6	Confirm there are suitable piping lengths upstream and downstream of the valve installation site in order to minimize a sudden pressure surge in the flow.	<i>Absence of suitable piping lengths can create critical operating conditions and cause unacceptable levels of noise and vibration.</i>
7	Confirm removal of all hazards and ensure appropriate protective measures are in place.	<i>none</i>
8	Confirm flow direction to ensure the correct valve installation. Flow direction is indicated by the arrow on the valve body.	<i>Improper flow direction causes critical changes to operating conditions that may damage the control valve.</i>
9	Confirm that the air supply and instrument signal lines are dry and clear of dirt and oil.	<i>At a minimum, the instrument air must conform to ISA-7.0.011996 (ISO 8573-1 Compressed Air - Class 2) requirement or those of the accessory manufacturer.</i>
10	Confirm the valve is grounded in order to prevent an electrical discharge.	<i>Noncompliance may result in electrical discharges.</i>
11	Throttling control valves are typically equipped with a pneumatic actuator and valve positioner. Refer to the appropriate positioner manual for connections and maximum air supplies.	<i>An air filter regulator should be installed to ensure that the supply pressure to the pneumatic actuator does not exceed the air supply pressure indicated on the serial plate.</i>

Table 1: Basic safety messages for installing the valve

## Valtek® MaxFlo 4™ Eccentric Rotary Plug Control Valve

After these requirements are confirmed, the valve can be installed and connected in the piping.

1. Remove the protective flange covers and coating from the control valve; clean the flange gasket surface.

**NOTICE** *Unsuitable cleaning agents can damage and cause leakage in PTFE and graphite gaskets. Consult a current chemical resistance list before applying.*

2. Whenever possible the valve should be installed so that actuator is in an upright position. Vertical installation of the actuator permits easier valve maintenance.

3. Install and connect the control valve to the pipeline. Locate gaskets in the center of the body flanges and secure nuts and bolts. Use the bolts indicated in the Table 2 for installing the valve in the pipeline, and then tighten alternately according to good practice. The user must in all cases confirm the capacity of the bolts to ensure a sufficiently tight gasket seal for the expected service.

4. Connect the power supply and instrument signal lines.
  - Connect the air supply and instrument signal lines.

Table 2: Line flange bolting specifications

Valve size	Pressure rating	MaxFlo 4 flanged		MaxFlo 4 flangeless	
		Size X length	Qty	Size X length	Qty
1" DN25	ANSI 150	1/2 X 2.62	8	1/2 X 6.75	4
	ANSI 300	5/8 X 3.12	8	5/8 X 6.88	4
	ANSI 600	5/8 X 3.50	8	5/8 X 7.12	4
	PN 16	M12 X 70	8	M12 X 175	4
	PN 40	M12 X 70	8	M12 X 175	4
	PN 63	M16 X 110	8	M16 X 210	4
1½" DN40	ANSI 150	1/2 X 2.88	8	1/2 X 7.50	4
	ANSI 300	3/4 X 3.62	8	3/4 X 8.38	4
	ANSI 600	3/4 X 4.25	8	3/4 X 8.75	4
	PN 16	M16 X 80	8	M16 X 200	4
	PN 40	M16 X 80	8	M16 X 200	4
	PN 63	M20 X 120	8	M20 X 235	4
2" DN50	ANSI 150	5/8 X 3.25	8	5/8 X 8.38	4
	ANSI 300	5/8 X 3.50	16	5/8 X 3.50	4
				5/8 X 8.50	6
	ANSI 600	5/8 X 4.25	16	5/8 X 4.25	8
				5/8 X 9.13	4
	PN 16	M16 X 85	8	M16 X 215	4
PN 40	M16 X 85	8	M16 X 215	4	
PN 63	M20 X 120	8	M20 X 245	4	
3" DN80	ANSI 150	5/8 X 3.62	8	5/8 X 10.5	4
	ANSI 300	3/4 X 4.25	16	3/4 X 4.25	4
				3/4 X 11.00	6
	ANSI 600	3/4 X 5.00	16	3/4 X 5.00	8
				3/4 X 11.50	4
	PN 16	M16 X 85	16	M16 X 85	6
PN 40	M16 X 95	16	M16 X 255	5	
PN 63	M20 X 125	16	M16 X 95	6	
4" DN100	ANSI 150	5/8 X 3.62	16	M16 X 265	5
				M20 X 125	8
	ANSI 300	3/4 X 4.50	16	M20 X 290	4
				M20 X 125	8
	ANSI 600	7/8 X 5.75	16	M20 X 290	4
				M20 X 125	8
	PN 16	M16 X 85	16	5/8 X 3.62	4
				5/8 X 11.5	6
	PN 40	M20 X 100	16	3/4 X 4.50	4
				3/4 X 12.25	6
	PN 63	M24 X 135	16	7/8 X 5.75	8
				M24 X 135	8
				M16 X 85	6
				M16 X 285	5
				M20 X 100	6
				M20 X 300	5
				M24 X 135	8
				M24 X 330	4

Valve size	Pressure rating	MaxFlo 4 flanged		MaxFlo 4 flangeless	
		Size X length	Qty	Size X length	Qty
6" DN150	ANSI 150	3/4 X 3.75	16	3/4 X 3.75	4
				3/4 X 13.25	6
	ANSI 300	3/4 X 4.88	24	3/4 X 4.88	8
				3/4 X 14.00	8
	ANSI 600	1 X 6.75	24	1 X 6.75	8
				1 X 15.75	8
	PN 16	M20 X 100	16	M20 X 100	4
				M20 X 335	6
	PN 40	M24 X 115	16	M24 X 115	4
				M24 X 350	6
PN 63	M30 X 160	16	M30 X 160	8	
			M30 X 390	4	
8" DN200	ANSI 150	3/4 X 4.25	16	3/4 X 4.25	8
	ANSI 300	7/8 X 5.50	24	7/8 X 5.50	4
				7/8 X 15.19	10
	ANSI 600	1 1/8 X 7.50	24	1 1/8 X 7.50	8
				1 1/8 X 17.00	8
	PN 16	M20 X 100	24	M20 X 100	8
				M20 X 350	8
	PN 40	M27 X 135	24	M27 X 135	8
				M27 X 385	8
	PN 63	M33 X 180	24	M33 X 180	8
M33 X 420				8	
10" DN250	ANSI 150	7/8 X 4.62	24		
	ANSI 300	1 X 6.25	32		
	ANSI 600	1 1/4 X 8.50	32		
	PN 16	M24 X 110	24		
	PN 40	M30 X 150	24		
	PN 63	M33 X 185	24		
12" DN300	ANSI 150	7/8 X 4.75	24		
	ANSI 300	1 1/8 X 6.75	32		
	ANSI 600	1 1/4 X 8.75	40		
	PN 16	M24 X 115	24		
	PN 63	M33 X 200	32		

## 10 Valve Quick-Check

Apply appropriate personal protective equipment when working on the control valve to prevent hazards arising from the operation. Protect yourself against freezing, burns and cuts by wearing appropriate protective clothing, gloves and eye protection.

Do not over-tighten packing.

Sudden exposure of the control valve to full working pressure and temperature may cause stress cracks.

**!** Prior to valve operation, we require, that you check the following conditions to reduce the risk of malfunction and safety-related incidents.

No.	Important information	Possible malfunction or safety-related incident
1	Avoid critical operating conditions where excessive noise or vibration levels might occur.	<i>Impermissible continuous operation of a control valves under critical conditions can damage the valve.</i>
2	Avoid frequent system start-ups and shutdowns.	<i>Critical operating conditions, which can damage the control valve, may be encountered during system start-up or shut down.</i>
3	Instrument air must conform to ISA 7.0.01-1996 (with a dew point at least 18°F (10°C) below ambient temperature, particle size below 1 µm and oil content not to exceed 1 ppm)	<i>Contaminated instrument air can damage the accessories and control valve or cause them to fail.</i>
4	<b>!</b> Do not touch the body and bonnet ! The temperature of the operating medium is transferred to the surface of the control valve.	Excessive hot surface temperatures can put you at risk for burns. Frigid surface temperatures can put you at risk for freezing.
5	<b>!</b> Critical operating conditions can cause excessive or hazardous levels of vibration or noise.	Impermissible levels of vibration can cause hearing loss, vascular and nerve damage and damage to joints and bones. Use hearing protection when noise levels exceed 80 dB(A).
6	<b>!</b> Incorrect maintenance can result in the emission of hot, cryogenic, and / or toxic operating media.	Incorrect maintenance can put you at risk for heat related burns, freezing, acid burns or poisoning.

Table 3: Basic safety messages for operating the valve

**WARNING** Due to risk of crushing hazard, do not work between the yoke legs while the valve is in operation.

Prior to start-up, we strongly recommend that you:

1. Stroke the valve and compare the plug position indicator on the stem clamp to the stroke indicator plate. The plug should change position in a smooth, linear fashion.

**NOTICE** Graphite packing commonly creates more friction than other materials, such as PTFE. If over tightened, excessive friction may impair smooth control.

2. Adjust instrument signals to ensure a full stroke.

3. Check the packing box bolting to ensure the correct adjustment (See Section 11: Valve Maintenance).

**NOTICE** Over tightening can cause excessive packing wear and high stem friction that may impede plug movement.

4. Continuously increase load until operation parameters are reached.
5. Minor relaxation of the flange bolting is possible after initial assembly. Retorque the bolting if necessary before installation or following an initial temperature excursion to ensure the gaskets do not leak.

## 11 Valve Maintenance

Maintenance intervals and service life of a valve can only be determined empirically on site. The intervals specified in the User Instructions are recommendations and serve only as a guide. Under problematic operating conditions, maintenance intervals may be significantly reduced. We strongly recom-

mend a site survey followed by establishing a documented procedure for performing the maintenance work. Maintenance personnel should perform and log the work accordingly. The data collected can be used as a basis for dynamically determining the maintenance intervals and activities.

Recommended Maintenance Actions					
No.	Service	Inter- val	Valve Condition		
			Good	Adequate	Inadequate
1	Visual inspection of the valve	Bi-weekly	No action	Clean valve stem with a soft cloth	Overhaul or replace valve after product lifecycle.
2	Visual inspection of the packing	Bi-weekly	No action	Retighten leaky packing box	Replace leaky packing box immediately
	Preventive change of the PTFE-packing	→	Dependent upon results of previous maintenance (see numbers 1 and 2 above) or a minimum of once every 24 months		
	Preventive change of the Graphite-packing	→	Dependent upon results of previous maintenance (see numbers 1 and 2 above) or a minimum of once every 18 months		
3	Visual inspection of body bolting	Yearly	No action	Retighten body bolting if bonnet gasket leaks.	Remove from service and replace body bolting immediately if gasket leakage persists or if bolting is damaged.
4	Visual inspection of the actuator	Bi-weekly	No action	Clean actuator stem with a soft cloth	Overhaul or replace actuator after product lifecycle.
5	Preventive overhaul of the valve	→	Dependent upon results of previous maintenance (see numbers 1 to 4 above) or a minimum once every 60 months		

Table 4: Service activities checklist



No.	Service	Inter-val	Valve Condition		
			Good	Adequate	Inadequate
6	Operation test	→	No action	Perform 3 full strokes if packing and / or bonnet tightening is modified; check for leakage	
<b>Recommended maintenance actions using the Logix digital positioner with ValveSight diagnostic solution software</b>					
7	Visual inspection of diagnostic interface	Weekly	No action; valve is healthy	Take action per warning	Overhaul or replace required part per alarm
8	Check health parameter of valve	Warning	No action; valve is healthy	Replace packing box components per warning	Overhaul or replace valve after alarm
9	Check health parameter of actuator	Warning	No action; actuator is healthy	Check and retighten air supply	Overhaul or replace actuator after alarm
10	Check health parameter of control	Warning	No action; control is healthy	Overhaul or replace valve; trim and bonnet components must be checked and / or repaired after alarm	
11	Check health parameter of positioner	Warning	No action; positioner is healthy	Start step test	Overhaul or replace positioner after alarm

Table 4 continued: Service activities checklist

**! Prior to valve maintenance, we require that you check the following conditions to reduce the risk of malfunction and safety-related incidents.**

No.	Check	Possible malfunction or Safety-related Incident
1	Check the packing follower for proper tightness.	<p><i>The packing follower is spring loaded and factory adjusted. If leakage is detected around the packing follower tighten it clockwise using a wrench in quarter turn intervals until the leakage stops.</i></p> <p><i>Do not overtighten packing.</i></p> <p><i>Overtightened packing can cause excessive packing wear and high stem friction that may impede plug movement.</i></p> <p><i>If leakage cannot be stopped, the packing must be replaced.</i></p>
2	Check if all nuts and bolts are securely fastened.	<b>! Avoid critical operating conditions if excess noise or vibration levels occur during operation.</b>
3	Check valve for smooth, full-stroke operation. Unsteady stem movement could indicate an internal valve problem.	<i>Internal valve failure requires an immediate overhaul or control valve replacement by qualified staff.</i>

Table 5: Basic safety messages for maintenance the valve

After these requirements are confirmed, proceed with valve maintenance.

## 12 Troubleshooting

Contact customer service department or contract partner for any fault or defect found, otherwise the manufacturer’s guarantee shall be rendered null and void and the manufacturer released from any responsibility. If the user performs the repairs, these User Instructions must be adhered to and carried out in a competent manner. Original Equipment Manufacturer spare parts must be used to make the repair.

Defect	No.	Possible Causes	Remedy
Stem does not move	1.1	<ul style="list-style-type: none"> <li>No auxiliary energy supply to actuator and accessories (positioner, air filter regulator, solenoid valve, limit switch, and/or special accessories)</li> </ul>	<ul style="list-style-type: none"> <li>Pneumatic actuators: Check supply for leaks Check air pressure</li> </ul>
	1.2	<ul style="list-style-type: none"> <li>Mounted accessories do not work</li> </ul>	<ul style="list-style-type: none"> <li>See User Instructions for accessory manufacturer</li> </ul>
	1.3	<ul style="list-style-type: none"> <li>Pneumatic actuator is defective</li> </ul>	<ul style="list-style-type: none"> <li>Contact customer service department or contract partner</li> </ul>
	1.4	<ul style="list-style-type: none"> <li>Excessive tightening of the packing box</li> </ul>	<ul style="list-style-type: none"> <li>Loosen packing follower until valve operates properly <b>NOTICE !      Make sure there are no leaks.</b></li> </ul>
	1.5	<ul style="list-style-type: none"> <li>Valve trim worn or stuck</li> </ul>	<ul style="list-style-type: none"> <li>Contact customer service department or contract partner</li> </ul>
Jerky stem movement	2.1	<ul style="list-style-type: none"> <li>Damaged stem</li> </ul>	<ul style="list-style-type: none"> <li>Contact customer service department or contract partner</li> </ul>

Table 6: Troubleshooting

Defect	No.	Possible Causes	Remedy
Jerky stem movement	2.2	<ul style="list-style-type: none"> <li>Actuator not powerful enough</li> </ul>	<ul style="list-style-type: none"> <li>Compare actuator specifications on the serial plate with operation specifications of the facility. If incompatible, contact customer service department or contract partner</li> </ul>
Stem travel less than full stroke (0 to 100 %)	3.1	<ul style="list-style-type: none"> <li>Air supply pressure too low</li> </ul>	<ul style="list-style-type: none"> <li>Provide air at the pressure stated on the serial plate</li> </ul>
	3.2	<ul style="list-style-type: none"> <li>Improper adjustment of limit stops</li> </ul>	<ul style="list-style-type: none"> <li>Refer to the installation, operation and maintenance manual for the corresponding actuator</li> </ul>
	3.3	<ul style="list-style-type: none"> <li>Pneumatic actuators: Improper handwheel position</li> </ul>	<ul style="list-style-type: none"> <li>Move handwheel to limit position, otherwise contact factory for information</li> </ul>
	3.4	<ul style="list-style-type: none"> <li>Improperly adjusted or defective positioner</li> </ul>	<ul style="list-style-type: none"> <li>Readjust positioner to positioner manufacturer's specification</li> </ul>
	3.5	<ul style="list-style-type: none"> <li>Foreign particles in valve seat or damaged trim</li> </ul>	<ul style="list-style-type: none"> <li>Contact customer service department or contract partner</li> </ul>
Excessive valve seat leakage	4.1	<ul style="list-style-type: none"> <li>Damaged sealing surfaces on valve seat or plug</li> </ul>	<ul style="list-style-type: none"> <li>Contact customer service department or contract partner</li> </ul>
	4.2	<ul style="list-style-type: none"> <li>Foreign particles in seat area</li> </ul>	<ul style="list-style-type: none"> <li>Contact customer service department or contract partner</li> </ul>
	4.3	<ul style="list-style-type: none"> <li>Plug does not close fully</li> </ul>	<ul style="list-style-type: none"> <li>Refer to No. 3.1 to 3.4</li> </ul>
	4.4	<ul style="list-style-type: none"> <li>Improper seat adjustment</li> </ul>	<ul style="list-style-type: none"> <li>Refer to seat installation instructions in the Valve Reassembly section.</li> </ul>
Leaking packing box system	5.1	<ul style="list-style-type: none"> <li>Compression force on packing box too low</li> </ul>	<ul style="list-style-type: none"> <li>Slightly retighten packing box</li> </ul> <p><b>NOTICE ! Make sure stem can still move.</b></p>
	5.2	<ul style="list-style-type: none"> <li>Worn packing</li> </ul>	<ul style="list-style-type: none"> <li>Slightly retighten packing box</li> </ul> <p><b>NOTICE ! Make sure stem can still move.</b></p> <p>If the packing does not stop leaking, contact customer service department or contract partner</p>
	5.3	<ul style="list-style-type: none"> <li>Dirty stem</li> </ul>	<ul style="list-style-type: none"> <li>Clean stem with suitable cleaning agent</li> </ul>
	5.4	<ul style="list-style-type: none"> <li>Damaged stem</li> </ul>	<ul style="list-style-type: none"> <li>Contact customer service department or contract partner</li> </ul>
Leaking bonnet gasket	6.1	<ul style="list-style-type: none"> <li>Gasket compression is too low</li> </ul>	<ul style="list-style-type: none"> <li>Properly retighten bonnet bolting nuts crosswise</li> </ul>
	6.2	<ul style="list-style-type: none"> <li>Corrosion</li> </ul>	<ul style="list-style-type: none"> <li>Contact customer service department or contract partner</li> </ul>
Leaking body	7.1	<ul style="list-style-type: none"> <li>Corrosion or high velocity related damage</li> </ul>	<ul style="list-style-type: none"> <li>Contact customer service department or contract partner</li> </ul>
No limit switch signal	8.1	<ul style="list-style-type: none"> <li>Power supply to limit switch interrupted</li> </ul>	<ul style="list-style-type: none"> <li>Check power supply (connections, circuit breakers, voltage)</li> </ul>
	8.2	<ul style="list-style-type: none"> <li>Limit switch out of adjustment</li> </ul>	<ul style="list-style-type: none"> <li>Readjust limit switch operating distance; see limit switch data sheet</li> </ul>
Unstable positioner	9.1	<ul style="list-style-type: none"> <li>Defective positioner</li> </ul>	<ul style="list-style-type: none"> <li>See user instruction of the positioner manufacturer</li> </ul>

Table 6 continued: Troubleshooting

## 13 Disassembly and Reassembly

The MaxFlo 4 control valve is allowed to be disassembled and reassembled only by qualified staff - personnel who are familiar with disassembling, reassembling, installation and commissioning of this product, and possess the relevant qualifications in their field of activity.

When performing repairs, personnel are to follow these instructions using only **original** equipment manufacturer (OEM) spare parts and recommended special tools to ensure the reliability of the MaxFlo 4 control valve.

Only Flowserve trained and authorized personnel are allowed to repair (disassemble and reassemble) the MaxFlo 4 in hazard areas.

Valves are provided for oil and grease-less service or oxygen service may only disassembled and reassembled in clean rooms (ISO 14644- ISO 8, US FED STD 209 E - M 6.5, or equivalent).



### WARNING

Control valves are pressure vessels. Improper opening of the valve or actuator can result in bodily injury.



Prior to disassemble and reassemble, we require, that you check the following conditions to reduce the risk of malfunction and safety-related incidents.



No.	Important information	Possible malfunction or safety related incident
1	Disregarding these instructions may bring serious or harmful consequences.	<i>Failure to comply with these user instructions will render the manufacturer's guarantee and liability null and void. Unless otherwise agreed, the manufacturer's general terms and conditions of sale shall apply.</i>
2	 Always observe system safety instructions when preparing for and performing the repair procedure.	Potential hazards and their sources are under the operator's influence. The operator must observe national and international environmental regulations for control valve removal from the pipe and cleaning. Permissible exposure limits must be maintained, appropriate personal protective equipment must be used and service personnel must be properly instructed in performing the repair procedure.
3	 Make sure the pipeline is depressurized and in ambient state, also a suitable rigging (e.g. Endless Sling) and securing devices (e.g. Vee Trough with Stands / Vise) are readily available.	Remove the MaxFlo 4 from the pipeline in a depressurized and ambient state. Failure to do so can cause serious personal injury. The control valve is not equipped with integral stands, therefore guard against the valve from tipping over. Bodily injuries can be the result. Use appropriate clamps, blocking or other stabilizing support. Attachment to overhead crane can ensure stability.
4	Confirm that you have the required spare parts at the site.	<i>Not having the full complement of parts, accessories and tools can slow or stop repair work.</i>
5	 Confirm that you have the required tools available to manage the disassembly and reassembly	<b>Improper tools and / or improper use of tools can result in personal injury or damage to the parts.</b>
6	Review the serial plate information to identify the valve. The serial number and the part numbers needed are required when ordering spare parts.	<i>A serial plate used for product identification is attached on every control valve (See Section 3: Product Identification).</i>
7	Do not damage any valve surfaces during repair.	<i>Damaging the stem surface and / or packing area may lead to premature leakages in the packing area.</i>
8	Check all parts for damage such as scoring, deformities, corrosion or overexpansion.	<i>If in doubt, replace faulty parts. Never reuse gaskets.</i>

Table 7: Basic safety messages for repairing the control valve

# Valtek® MaxFlo 4™ Eccentric Rotary Plug Control Valve

Table 8: Parts list

Item	Description	Material
1	Body	A216-WCC / 1.0619
		A351-CF8M / 1.4408
20	Seat Ring	316L SS
		316L w/ Alloy 6
		416 SS HT
		316L / PTFE
30	Seat Retainer	Stainless Steel
40	Bonnet	Carbon Steel
		Stainless Steel
50	Plug	1.4418
		1.4405
		316L w/ Alloy 6
		CF3M w/ Alloy 6 (6"/DN 150 and larger)
51/122	Shaft / End Post	1.4418
		17-4PH H1150M
		17-4PH H1150D
		A638 Gr 660
46/83/84	Bearings	MBT <sup>1</sup>
		440C SS HT
		Ultimet
		UNS S31803
		Alloy 6
58/61	Gaskets	PTFE
		Graphite
80	Gland Flange	Stainless Steel
87	Packing Follower	Stainless Steel
88	Packing	PTFE V-ring
		Braided PTFE
		LATTYflon 3265 LM
		LATTYgraf 6995 NG
		Graphite Braid
93/99	Packing Spacers & Stops	Stainless Steel
108/114	Bonnet Bolting	Carbon Steel
		Stainless Steel
109/117	Gland Bolting	Stainless Steel
115/119	End Post Bolting	Carbon Steel
		Stainless Steel

**Note:** MBT, 10% carbon filled TFE, lined metal shell

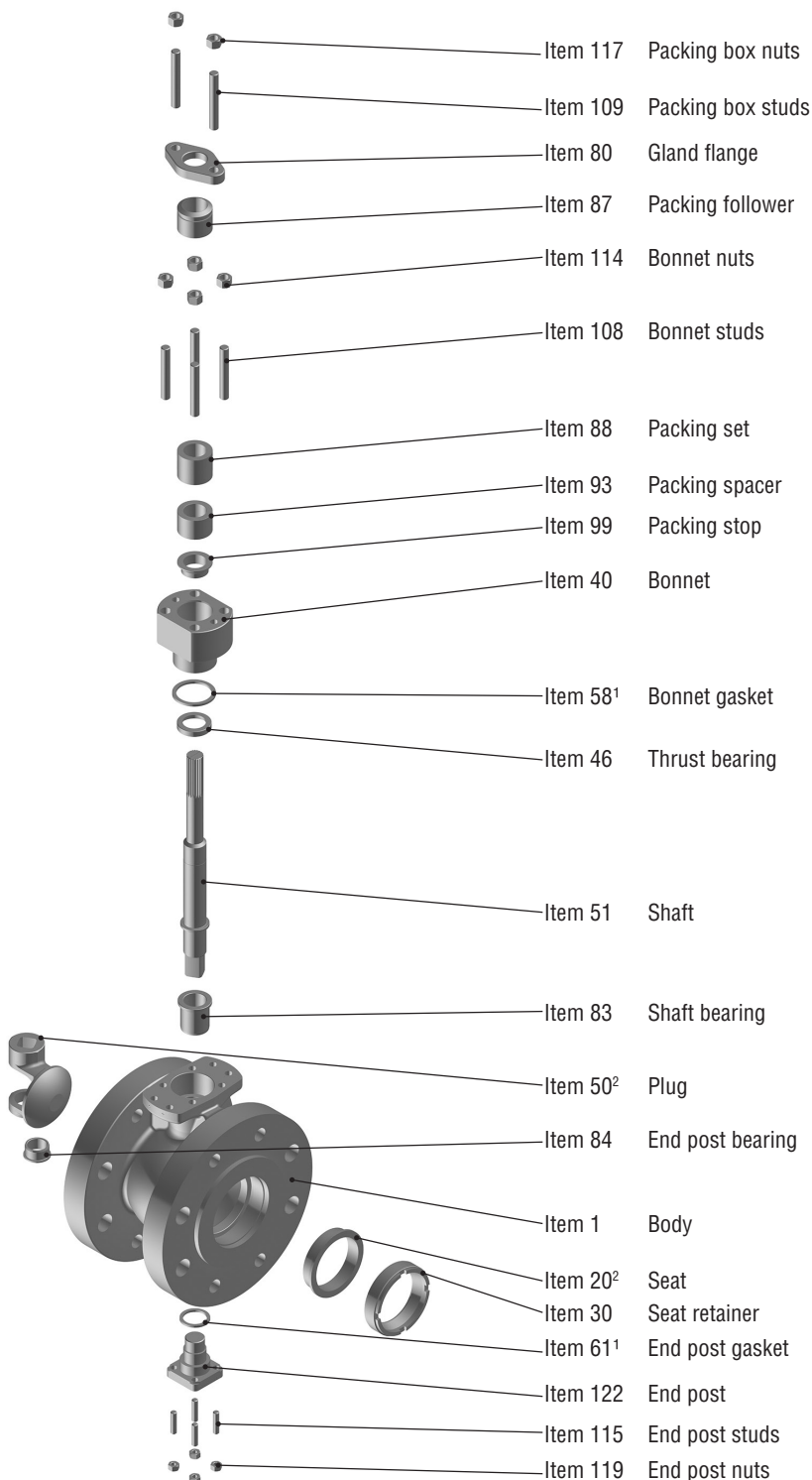

**Note 1:** Start-up/commissioning spares

**Note 2:** Two-year operation spares

Figure 3: Valve reassembly  
Item numbers correspond directly to the valve's bill of material.  
Refer to it for specific part numbers.

### Valve Disassembly

**⚠ WARNING:** To carry out this operation, it is essential to disconnect the valve from the pipework. Depressurize line to atmospheric pressure and drain all fluids before working on the valve. Failure to do so can cause serious injury. Remove the valve from the pipeline.

Refer to Figure 3 to find parts according to the item numbers.

- 13.1 Remove the actuator from the body by separating the actuator at the yoke. Refer to the installation, operation and maintenance manual for the corresponding actuator.
- 13.2 Remove the four bonnet nuts (item 114).
- 13.3 Remove the packing nuts and gland flange (item 80).
- 13.4 Carefully pull the shaft (item 51) out of the body. The bonnet, thrust bearing, packing stop and packing will all slide out of the body bore as an assembly.
  - ⚠ NOTE:** At this point in the disassembly operation, the plug is inside the valve body and is only supported by the end post. When removing the end post, support the plug so it does not drop into the bottom of the valve body.
- 13.5 Remove the end post nuts (item 119) and carefully remove the end post (item 122) from the body.
- 13.6 Remove the plug from the body. See Figure 4a.
- 13.7 Loosen the packing-box nuts (item 117) and remove the shaft from the bonnet by sliding it out slowly. The thrust bearing (item 46) and the shaft stop spacer (item 47, only for sizes 10 to 12") can now be removed from the shaft.
- 13.8 Remove the packing follower (item 87) as well as the packing (item 88), spacers (item 93) and the packing stop (item 99).
- 13.9 Remove the bonnet gasket (item 58) and end post gasket (item 61). Clean all bearing and seal surfaces.
- 13.10 Remove the shaft bearing (item 83) from the valve body. Use a suitable dowel to push the bearing out if necessary. Be careful not to damage the bearing.
- 13.11 Unscrew the seat retainer (item 30) using the appropriate tool (see Table 11) and remove the seat (item 20).

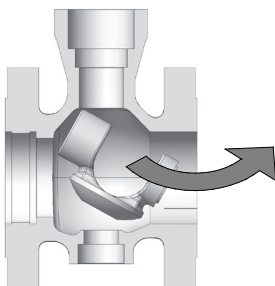

Figure 4a: Plug removal

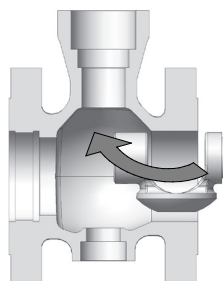

Figure 4b: Plug installation

### Valve Reassembly

**⚠ NOTE:** Lubricate all threads, bearings and the shaft shoulder (see Table 9). Place the valve body in a vice and clamp securely in a vertical position.

Table 9: Thread lubricants

Lubricant	Manufacturer	Temperature Range		Application Description
		°C	°F	
Boron Nitride NB1200	Molydal	-20°C to 1200°C	-4°F to 2192°F	Excellent resistance to water, steam and aggressive atmospheres
Nickle Anti Sieze LB 771 (77164)	Loctitie/Permatex	-54°C to 1315°C	-65°F to 2400°F	Resists galling and corrosion and reduces wear. Exceptionally resistant to attack by acids, ammonia, acetylene and vinyl monomer
Nickle Anti Sieze 725	Chestron	-54°C to 1425°C	-65°F to 2600°F	Resists galling and corrosion and reduces wear.
Krytox GP206	Krytox	-36°C to 260°C	-33°F to 500°F	Can be used on components that come in contact with chemicals, including alcohols, ammonia, solvents, steam, acids and bases, and oxygen systems, such as LOX and GOX.
Klüberalfa YV 93-1202	Kluber	-60°C to 200°C	-76°F to 392°F	Oxygen valves, chemicals

- 13.12 Always use new packing and gaskets when reassembling a valve.
- 13.13 Make sure that the shaft, bonnet bore and gasket surfaces in the body have been thoroughly cleaned (these are sealing surfaces and it is important to remove any contamination before reassembly).
- 13.14 Make sure that all bearing surfaces have been cleaned.
- 13.15 Insert the plug in the body as shown in Figure 4b.
  - ⚠ NOTE:** The end post bearing (item 84) is pressed into the plug.
- 13.16 Place the end post gasket (item 61) on the end post (item 122). Insert the end post into the small flanged port in the end of the body. As the end post is inserted, locate the plug (item 50) so the end post will insert into the end post bearing located in the plug.
  - ⚠ NOTE:** For valves 3" and larger, insert the end post with the milled faces parallel to the flanges of the valve body.
- 13.17 Tighten the end post nuts to finger tight.
- 13.18 Insert the shaft bearing (item 83) into the body until the shoulder on the bearing contacts the step in the valve body. The bearing will protrude slightly into the body gallery area.
- 13.19 Place the thrust bearing onto the shaft. Slide it up to the thrust runner. The shaft thrust bearing will surround the thrust runner.
  - ⚠ NOTE:** for sizes 10" and 12", an end spacer (item 47) is placed above the thrust bearing.

**Valtek® MaxFlo 4™ Eccentric Rotary Plug Control Valve**

13.20 Place the bonnet gasket (item 58) on the gasket step inside the body. Gently push the bonnet into the bonnet bore.



**NOTE:** When installing the bonnet, orient the milled faces on the bonnet perpendicular to the flanges of the valve body.

13.21 Place the packing stop (item 99) into the bonnet, then install the packing spacer (item 93) and packing set (item 88).

13.22 Install bonnet nuts and tighten to finger tight.

13.23 Install the packing follower (item 87) and gland flange (item 80), then tighten the packing nuts to finger tight.

13.24 Tighten the bonnet and end post nuts evenly. Torque nuts to the values listed in Table 10.

13.25 Rotate the plug into the closed position and visually confirm the plug head is centered in the seat area. Install the seat ring (Item 20) and screw in the seat retainer (item 30) using the appropriate seat retainer tool and required torque values (see Table 11).

13.26 Install the actuator and yoke as described in the installation manual for the corresponding actuator.

13.27 Install the valve into the process line as described in the installation section.

Table 10: Nut tightening torques for bonnet and post

Stud Size	A193-B7	A193-B8 cl2	A453-Gr660 (Nace)
M8	12 ft-lb / 16 Nm	7.5 ft-lb / 10 Nm	10.5 ft-lb / 14 Nm
M12	43.5 ft-lb / 59 Nm	27.5 ft-lb / 37 Nm	30.5 ft-lb / 41 Nm
M16	62.5 ft-lb / 85 Nm	39 ft-lb / 53 Nm	43.5 ft-lb / 59 Nm

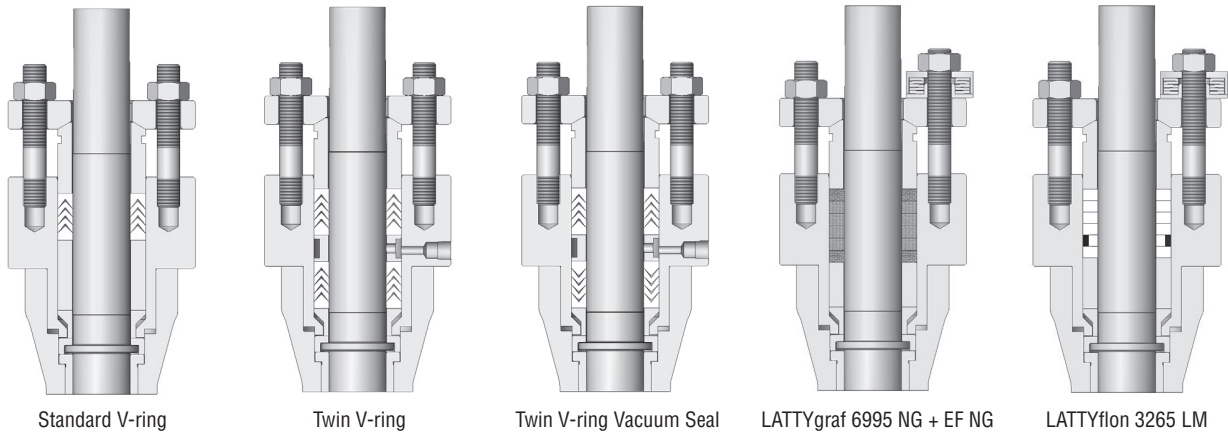

Figure 5: Packing configurations

Table 11: Seat retainer removal tools and required torque values

Valve size	Face-to-Face	
	ANSI/ISA-75.08.02, EN 558.1/2 series 36, IEC 60534-3-2, DIN 3202 F1, EN 558-1/2 series 1	ANSI/ISA-75.08.0, EN 558-1/2 series 37-38, IEC 60534-3-1
1" DN 25	Part number: 183224.999.000 Torque: 41 ft-lbs / 55 Nm	
1.5" DN 40	Part number: 183225.999.000 Torque: 103 ft-lbs / 140 Nm	
2" DN 50	Part number: 183226.999.000 Torque: 155 ft-lbs / 210 Nm	
3" DN 80	Part number: 183227.999.000 Torque: 406 ft-lbs / 550 Nm	
4" DN 100	Part number: 183228.999.000 Torque: 428 ft-lbs / 580 Nm	
6" DN 150	Part number: 183229.999.000 Torque: 959 ft-lbs / 1300 Nm	
8" DN 200	Part number: 183230.999.000 Torque: 701 ft-lbs / 950 Nm	Part number: 183229.999.000 Torque: 959 ft-lbs / 1300 Nm
10" DN 250	Part number: 183231.999.000 Torque: 553 ft-lbs / 750 Nm	Part number: 183230.999.000 Torque: 701 ft-lbs / 950 Nm
12" DN 300	Part number: 183232.999.000 Torque: 752 ft-lbs / 1020 Nm	Part number: 183231.999.000 Torque: 553 ft-lbs / 750 Nm

## 14 Disposal

Up to 95% of the MaxFlo 4 control valve is metal. The remaining materials are synthetic, rubber, polytetrafluoroethylene (PTFE), graphite, paint and lubricants.

**NOTICE** Potential hazards and their sources are under the operator's influence. The operator must observe national and international environmental conditions for control valve removal from the pipeline and cleaning. Permissible limit values must be maintained to ensure suitable protective measures; service personnel must be properly instructed in performing the disassembly and reassembly procedure.

The valve should be professionally disassembled and reassembled. Metal parts should be scrapped, with the remaining materials disposed of according to the national conditions.

Peripheral units (accessories) should be recycled according to the relevant manufacturer's User Instructions.



Flowserve Corporation  
5215 North O'Connor Blvd.  
Suite 700  
Irving, Texas 75039-5421 USA

**VAIOM001457-03 (EN/A4)** March 2024  
*(Formerly VLENIM0064)*

Flowserve Corporation has established industry leadership in the design and manufacture of its products. When properly selected, this Flowserve product is designed to perform its intended function safely during its useful life. However, the purchaser or user of Flowserve products should be aware that Flowserve products might be used in numerous applications under a wide variety of industrial service conditions. Although Flowserve can provide general guidelines, it cannot provide specific data and warnings for all possible applications. The purchaser/user must therefore assume the ultimate responsibility for the proper sizing and selection, installation, operation, and maintenance of Flowserve products. The purchaser/user should read and understand the Installation Instructions included with the product, and train its employees and contractors in the safe use of Flowserve products in connection with the specific application.

While the information and specifications contained in this literature are believed to be accurate, they are supplied for informative purposes only and should not be considered certified or as a guarantee of satisfactory results by reliance thereon. Nothing contained herein is to be construed as a warranty or guarantee, express or implied, regarding any matter with respect to this product. Because Flowserve is continually improving and upgrading its product design, the specifications, dimensions and information contained herein are subject to change without notice. Should any question arise concerning these provisions, the purchaser/user should contact Flowserve Corporation at any one of its worldwide operations or offices.

©2024 Flowserve Corporation. All rights reserved. This document contains registered and unregistered trademarks of Flowserve Corporation. Other company, product, or service names may be trademarks or service marks of their respective companies.